

## PRODUCT OVERVIEW

## 产品定制服务

OEM/ODM

03

## 磁性固定制品

Holding Magnet Assemblies

锅磁吸盘	Pot Magnet	04~09
磁性挂钩	Hook Magnet	10~15
打捞磁铁	Fishing Magnet	16~19
包胶磁铁	Rubber Coated	20~25
图钉磁铁	Pin Magnet	26~29
磁性夹	Magnetic Clip	30
胸牌磁铁	Name Badge Magnet	31

## 磁性工具制品

Magnetic Tools

磁性捡拾器	Magnetic Pickup Tool	32
磁性工具架	Magnetic Tool Holder	33~35
焊接固定磁铁	Welding Magnet	36~40

## 磁分离系列

Magnetic Separation

特氟龙磁棒	Teflon coated magnet	40
-------	----------------------	----

## 设备系列

Equipment

小型数显拉力机	Small Digital Tension Machine	41
---------	-------------------------------	----

## 配件系列

Accessories

打捞磁铁配件	Fishing Magnet Accessories	42~45
--------	----------------------------	-------

## 表面处理

Surface Treatment

## 更新 Update

2025-8更新:

更改部分产品参数

### \* 产品拉力说明:

本册中标注的拉脱力(释义)分为垂直拉脱力和平行拉脱力,均是在常温下由产品与10mm抛光钢板以80mm/min的速度匀速拉脱测得,不同的测试设备或测试条件会对拉脱力数据产生影响。我司以拉脱力作为产品的一项磁力性能指标,如对产品有定制化需求,请和我们联系。

The pull-off force (interpretation) marked in this book is divided into vertical pull-out force and horizontal pull-out force, both of which are measured by pulling the product and 10mm polished steel plate at a constant speed of 80mm/min at room temperature. Different testing equipment or conditions may affect the pull-out force data. Our company uses pull-off force as a magnetic performance indicator for our products. If you have customized requirements for our products, please contact us.

### \* 释义:

拉脱力: 又称拉拔力, 通常是指在材料力学或工程领域中, 使物体相互连接的部分发生分离或破坏的力。我司以P.O. Force作为英文简称。

垂直拉脱力: 与吸附面垂直方向测得的拉脱力。我司以V.P.O. Force作为英文简称。

平行拉脱力: 与吸附面平行方向测得的拉脱力。我司以P.P.O. Force作为英文简称。

### INTERPRETATION:

Pull-off force: also known as pull-out force, usually refers to the force in the field of materials mechanics or engineering that causes separation or failure of the interconnected parts of an object. We uses P.O. Force as abbreviation.

Vertical pull-off force: The pull-off force measured perpendicular to the adsorption surface. We uses V.P.O. Force as abbreviation.

Parallel pull-off force: The pull-off force measured parallel to the adsorption surface. We uses P.P.O. Force as abbreviation.

### \* 图示 Illustration:

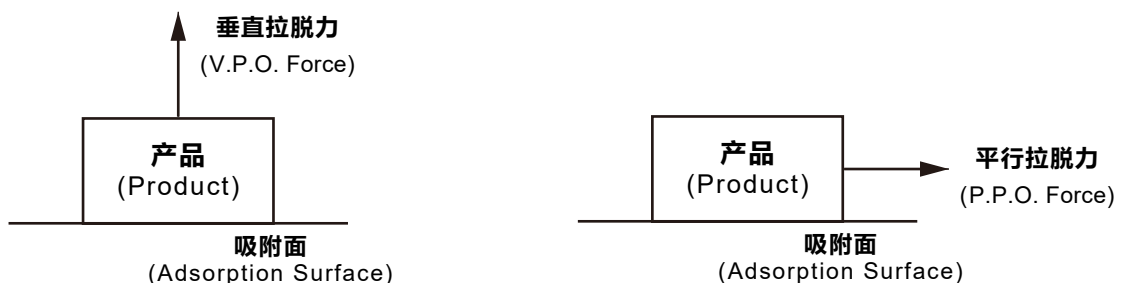

### \* 产品变更说明:

本目录册内容及产品技术规格如有变更, 恕不另行通知。

The contents of this catalog and product technical specifications are subject to change without notice.

# PRODUCT INFORMATION

我们可为客户提供从产品研发、设计制造到后期维护的全部服务，客户只需提出产品的功能、性能或只需提供产品的构思，揽胜可将产品从设想变为现实。

We can provide customers with all services from product development, design and manufacturing to later maintenance. Customers only need to propose the product's function, performance or just provide the idea of the product, LANCE can turn the product from the idea to reality.

## 产品案例 Product Case

### 结构设计 Physical Design

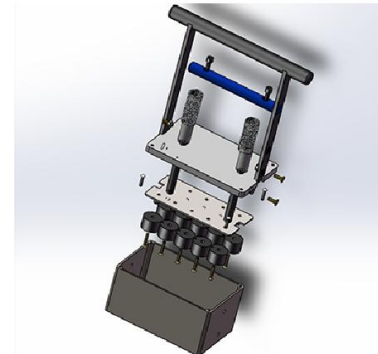
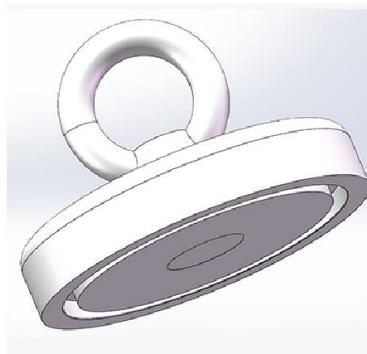
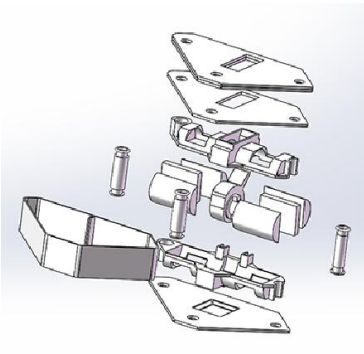

### 磁路设计 Magnetic Field Design

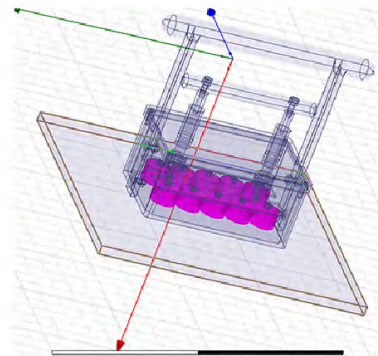
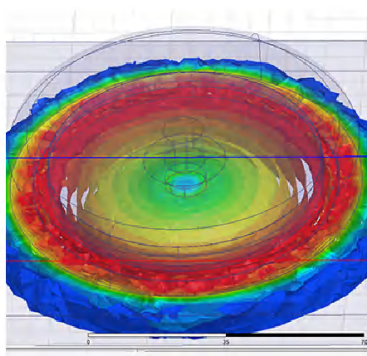
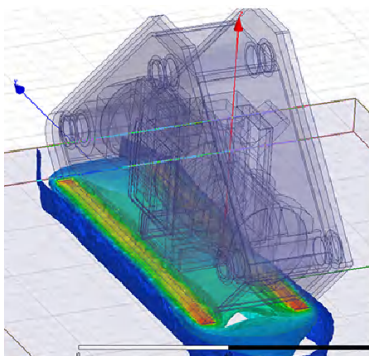

### 产品完成 Fished Product



# PRODUCT INFORMATION

## 锅磁系列 Pot Magnet

钕铁硼锅磁, 沉头孔, 电镀Nickel

Neodymium pot magnet, with counter bore, nickel coating

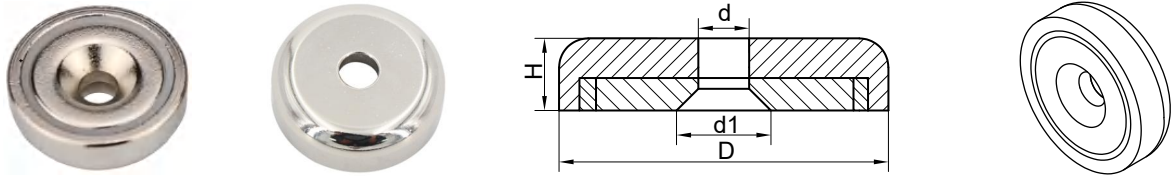

型号 Model	D (mm)	d (mm)	d1 (mm)	H (mm)	自重 Weight (g)	垂直拉脱力 V.P.O.Force (kg)
SNA12	12	3.5	6.5	5	4	2.5
SNA16	16	3.5	6.5	5	7	6
SNA20	20	4.5	8.6	7	14	11
SNA25	25	5.5	10.6	8	25	20
SNA32	32	5.5	10.6	8	42	32
SNA36	36	6.5	11.3	8	54	43
SNA42	42	6.5	11.3	8.6	78	65
LNA48	48	8.5	15.5	11	138	75
LNA55	55	8.5	14.5	12	205	95
LNA60	60	8.5	14.5	15	305	160
LNA70	70	10.5	16.5	17	485	210
LNA75	75	10.5	16.5	18	560	250
LNA80	80	10.5	16.5	18	668	280
LNA90	90	10.5	16.5	18	850	380
LNA120	120	12.5	22.5	18	1520	480

## 锅磁系列 Pot Magnet

钕铁硼锅磁, 直孔, 电镀Nickel

Neodymium pot magnet, with bore, nickel coating

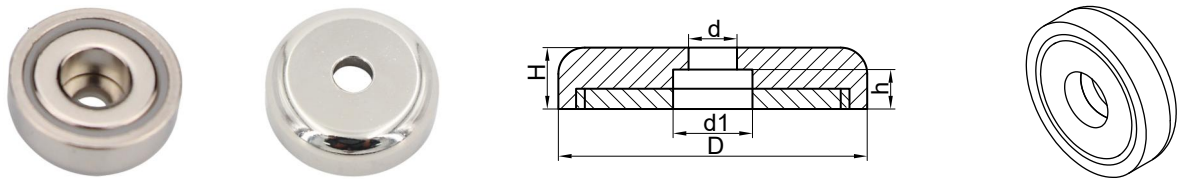

型号 Model	D (mm)	d (mm)	d1 (mm)	H (mm)	h (mm)	自重 Weight (g)	垂直拉脱力 V.P.O.Force (kg)
SNB12	12	3.5	6.5	4.5	3.5	4	2
SNB16	16	3.5	6.5	5	3.5	7	5
SNB20	20	4.5	8	7	4.5	13	10
SNB25	25	5.5	9	8	5.5	19	18
SNB32	32	5.5	9	8	5.5	38	30
SNB36	36	6.5	11	8	6.5	48	40
SNB42	42	6.5	11	8.6	6.5	70	60
LNB48	48	8.5	15	11	8.5	115	70
LNB60	60	8.5	15	15	8.5	240	150
LNB75	75	10.5	18	18	10.5	515	220

# PRODUCT INFORMATION

## 锅磁系列 Pot Magnet

钕铁硼锅磁, 外螺纹, 电镀Nickel

Neodymium pot magnet, with external thread, nickel coating

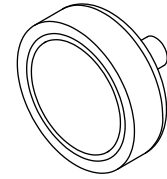
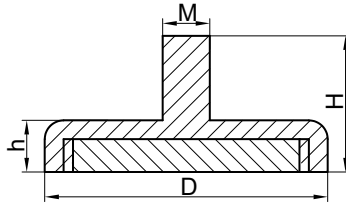

型号 Model	D (mm)	H (mm)	h (mm)	M	自重 Weight (g)	垂直拉脱力 V.P.O.Force (kg)
SNC10	10	14	5	M3	4	2
SNC12	12	14	5	M3	5	4
SNC16	16	13.2	5	M4	8	8
SNC20	20	16	7	M4	17	12
SNC25	25	17	8	M5	30	23
SNC32	32	18.5	8	M6	50	34
SNC36	36	18	8	M6	62	50
SNC42	42	18	8.6	M6	89	72
LNC48	48	24	11	M8	152	81
LNC60	60	28	15	M8	325	160
LNC75	75	35	18	M10	620	250

## 锅磁系列 Pot Magnet

钕铁硼锅磁, 内螺纹, 电镀Nickel

Neodymium pot magnet, with screwed bush, nickel coating

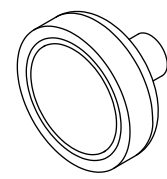
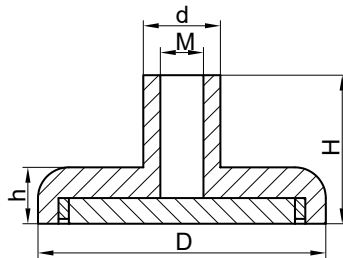

型号 Model	D (mm)	d (mm)	H (mm)	h (mm)	M	自重 Weight (g)	垂直拉脱力 V.P.O.Force (kg)
SND10	10	6	12.5	5	M3	4	2
SND12	12	6	12.5	5	M3	5	4
SND16	16	6.5	12.6	5	M4	9	8
SND20	20	6.5	14	7	M4	17	12
SND25	25	7.5	17	8	M5	31	23
SND32	32	10	18	8	M6	52	34
SND36	36	10	18	8	M6	60	50
SND42	42	10	18	8.6	M6	95	72
LND48	48	12	24	11	M8	160	81
LND60	60	12	28	15	M8	340	160
LND75	75	17	35	18	M10	635	250

# PRODUCT INFORMATION

## 锅磁系列 Pot Magnet

钕铁硼锅磁, 平螺纹-公制, 电镀Nickel

Neodymium pot magnet, with internal thread-metric thread, nickel coating

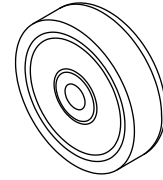
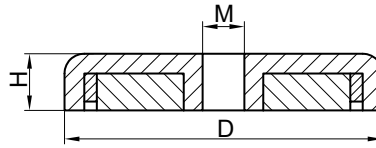

型号 Model	D (mm)	H (mm)	M	自重 Weight (g)	垂直拉脱力 V.P.O.Force (kg)
SNH16	16	5	M3	7	4
SNH20	20	7	M4	14	8
SNH25	25	7.7	M5	25	17
SNH32	32	7.7	M5	44	27
SNH36	36	7.5	M6	55	36
SNH42	42	8.6	M6	86	50
SNH48	48	10.6	M8	132	70
LNH60	60	12	M8	229	140
LNH75	75	15	M10	464	220

## 锅磁系列 Pot Magnet

钕铁硼锅磁, 电镀Nickel

Neodymium pot magnet, nickel coating

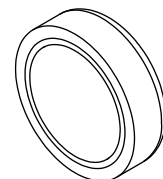
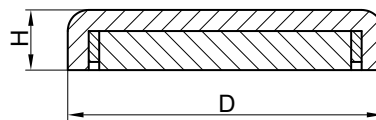

型号 Model	D (mm)	H (mm)	自重 Weight (g)	垂直拉脱力 V.P.O.Force (kg)
SNO16	16	5.2	8	8
SNO20	20	7.2	16	12
SNO25	25	7.7	25	22
SNO32	32	7.8	40	34
SNO36	36	7.6	51	41
SNO40	40	7.8	70	51
SNO42	42	8.8	78	68
SNO48	48	10.8	121	78
SNO60	60	15	245	120
SNO75	75	17.8	485	178

# PRODUCT INFORMATION

## 锅磁系列 Pot Magnet

钕铁硼方形锅磁，沉孔，电镀Nickel

Rectangular neodymium pot magnet, with counter bore, nickel coating

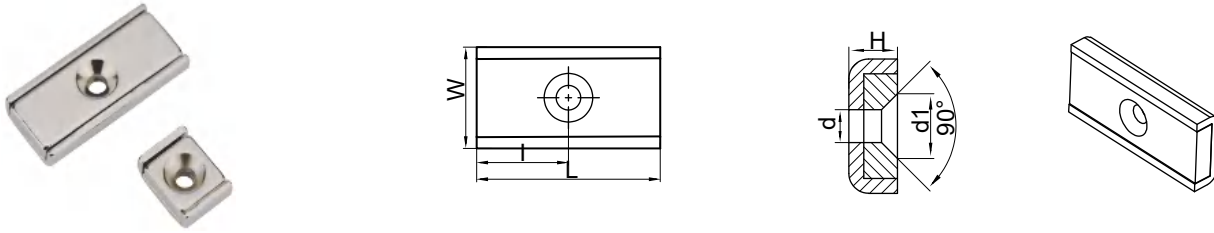

型号 Model	L (mm)	l (mm)	W (mm)	H (mm)	d (mm)	d1 (mm)	自重 Weight (g)	垂直拉脱力 V.P.O.Force (kg)
SNI10	10	5	13.2	5	3.3	6.5	5	4
SNI15	15	7.5	13.2	5	3.3	6.5	7	7
SNI20	20	10	13.2	5	3.3	6.5	10	8
SNI30	30	15	13.2	5	3.3	6.5	15	16

## 锅磁系列 Pot Magnet

钕铁硼方形锅磁，沉孔，电镀Nickel

Rectangular neodymium pot magnet, with counter bore, nickel coating

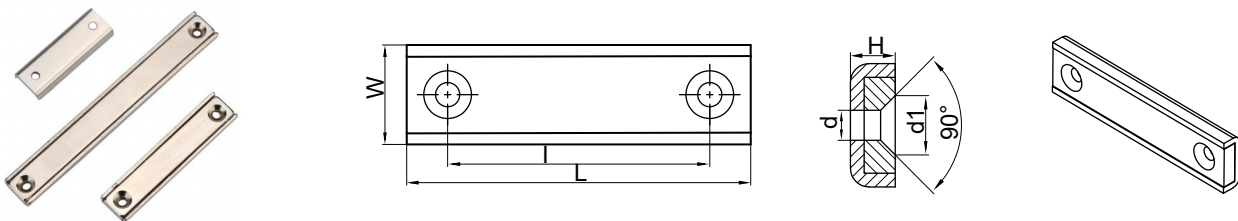

型号 Model	L (mm)	l (mm)	W (mm)	H (mm)	d (mm)	d1 (mm)	自重 Weight (g)	垂直拉脱力 V.P.O.Force (kg)
SNI40	40	30	13.2	5	3.3	6.5	19	17
SNI50	50	40	13.2	5	3.3	6.5	24	27
SNI60	60	50	13.2	5	3.3	6.5	30	30
SNI80	80	70	13.2	5	3.3	6.5	38	33
SNI100	100	90	13.2	5	3.3	6.5	48	36
SNI120	120	110	13.2	5	3.3	6.5	58	40

# PRODUCT INFORMATION

## 锅磁系列 Pot Magnet

钕铁硼锅磁, 平螺纹-公制, 电镀Nickel

Neodymium pot magnet, with internal thread-metric thread, nickel coating

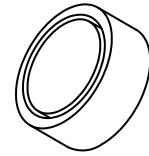
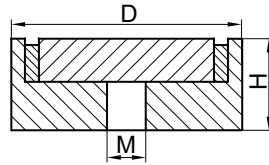

型号 Model	D (mm)	H (mm)	M	自重 Weight (g)	垂直拉脱力 V.P.O.Force (kg)
LNP10	10	8	M3	5	2
LNP12	12	8	M3	7	4
LNP16	16	8	M4	12	8
LNP20	20	10	M4	24	12
LNP25	25	10	M5	37	23
LNP32	32	10	M6	61	34
LNP36	36	10	M6	77	50
LNP42	42	15	M6	158	72
LNP48	48	15	M8	206	81
LNP60	60	15	M8	322	160
LNP75	75	20	M10	672	270

# PRODUCT INFORMATION

## 锅磁系列 Pot Magnet

铁氧体锅磁, 外螺纹, 电镀Zinc

Ferrite pot magnet, with external thread, zinc coating

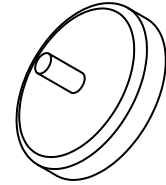
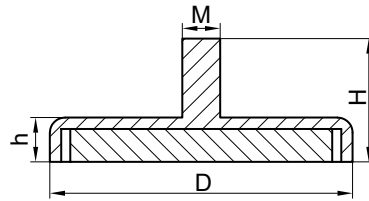

型号 Model	D (mm)	H (mm)	h (mm)	M	自重 Weight (g)	垂直拉脱力 V.P.O.Force (kg)
SFC25	25	16.1	7.4	M4	21	4.5
SFC32	32	15.6	6.9	M4	30	8.5
SFC36	36	16.6	7.9	M4	43	11
SFC40	40	18.4	7.9	M5	52	13
SFC47	47	19	9	M5	82	18
SFC50	50	19.9	9.9	M5	103	23
SFC57	57	20.4	10.4	M5	141	29
SFC63	63	26	14	M6	211	36
SFC80	80	29	18	M8	417	62

## 锅磁系列 Pot Magnet

铁氧体锅磁, 内螺纹, 电镀Zinc

Ferrite pot magnet, with screwed bush, zinc coating

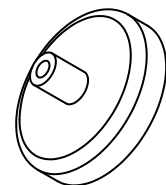
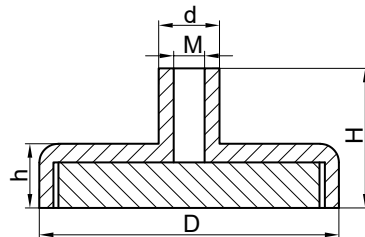

型号 Model	D (mm)	d (mm)	H (mm)	h (mm)	M	自重 Weight (g)	垂直拉脱力 V.P.O.Force (kg)
SFD25	25	6.5	15.5	7.4	M4	22	4.5
SFD32	32	6.5	15	6.9	M4	31	8.5
SFD36	36	6.5	16	7.9	M4	45	11
SFD40	40	7.5	17.9	7.9	M5	55	13
SFD47	47	7.5	18.5	9	M5	84	18
SFD50	50	7.5	19.4	9.9	M5	105	23
SFD57	57	7.5	19.9	10.4	M5	144	29
SFD63	63	10	25.5	14	M6	215	36
SFD80	80	10	31.2	18	M8	421	62

# PRODUCT INFORMATION

## 磁性挂钩系列 Hook Magnet

钕铁硼磁性挂钩, 开口挂钩, 电镀Nickel

Neodymium hook magnet, with hook, nickel coating

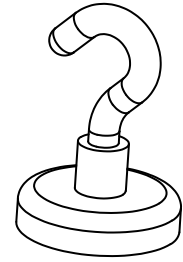
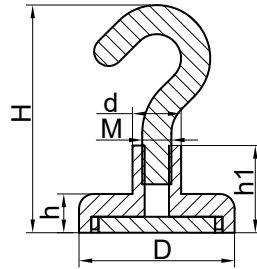

型号 Model	D (mm)	d (mm)	h (mm)	h1 (mm)	H (mm)	M	自重 Weight (g)	垂直拉脱力 V.P.O.Force (kg)
SNE10	10	6	5	12.5	33	M3	6	2
SNE12	12	6	5	12.5	33	M3	7	4
SNE16	16	6.5	5	12.6	35	M4	12	8
SNE20	20	6.5	7	14	36	M4	21	12
SNE25	25	7.5	8	17	45	M5	37	23
SNE32	32	10	8	18	48	M6	61	34
SNE36	36	10	8	18	48	M6	69	50
SNE42	42	10	8.6	18	48	M6	101	72
LNE48	48	12	11	24	61	M8	182	81
LNE60	60	12	15	28	64.8	M8	362	160
LNE75	75	17	18	35	81	M10	681	270

## 磁性挂钩系列 Hook Magnet

钕铁硼磁性挂钩, 闭合挂钩, 电镀Nickel

Neodymium hook magnet, with eyelet hook, nickel coating

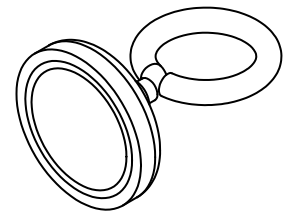
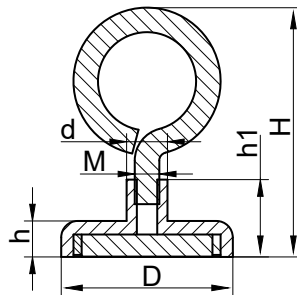

型号 Model	D (mm)	d (mm)	h (mm)	h1 (mm)	H (mm)	M	自重 Weight (g)	垂直拉脱力 V.P.O.Force (kg)
SNF10	10	6	5	12.5	33	M3	7	2
SNF12	12	6	5	12.5	33	M3	8	4
SNF16	16	6.5	5	12.6	34.6	M4	12	8
SNF20	20	6.5	7	14	36	M4	21	12
SNF25	25	7.5	8	17	44.5	M5	38	23
SNF32	32	10	8	18	47.5	M6	63	34
SNF36	36	10	8	18	47.5	M6	71	50
SNF42	42	10	8.6	18	47.5	M6	106	72
LNF48	48	12	11	24	60.5	M8	187	81
LNF60	60	12	15	28	64.5	M8	367	160
LNF75	75	17	18	35	91	M10	697	270

# PRODUCT INFORMATION

## 磁性挂钩系列 Hook Magnet

钕铁硼磁性挂钩, 180度旋转挂钩, 电镀Nickel

Neodymium hook magnet, with hook, nickel coating

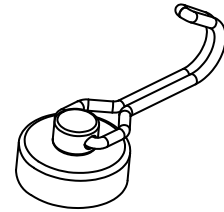
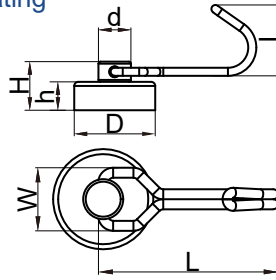

型号 Model	D (mm)	d (mm)	h (mm)	H (mm)	L (mm)	W (mm)	l (mm)	自重 Weight (g)	垂直拉脱力 V.P.O.Force (kg)	平行拉脱力 P.P.O.Force (kg)
SNG16-1	16	8	6	11	26	11.7	16.3	13	5.5	2

## 磁性挂钩系列 Hook Magnet

钕铁硼磁性挂钩, 360度旋转挂钩, 电镀Nickel

Neodymium hook magnet, with hook, nickel coating

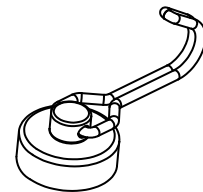
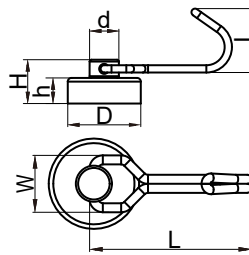

型号 Model	D (mm)	d (mm)	h (mm)	H (mm)	L (mm)	W (mm)	l (mm)	自重 Weight (g)	垂直拉脱力 V.P.O.Force (kg)	平行拉脱力 P.P.O.Force (kg)
SNG20-1	20	8	7	12	35	11.2	17.4	19	9.5	3.5

## 磁性挂钩系列 Hook Magnet

钕铁硼磁性挂钩, 旋转挂钩, 电镀Nickel

Neodymium hook magnet, with swivel hook, nickel coating

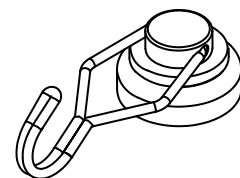
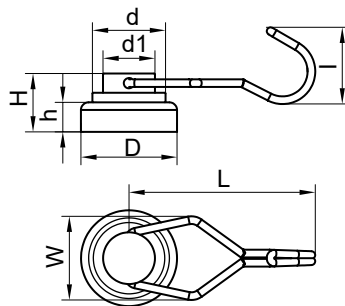

型号 Model	D (mm)	d (mm)	d1 (mm)	h (mm)	H (mm)	L (mm)	W (mm)	l (mm)	自重 Weight (g)	垂直拉脱力 V.P.O.Force (kg)	平行拉脱力 P.P.O.Force (kg)
SNG25	25	20	13.5	8	15.5	53.5	23	24	38	21	7.5
SNG32	32	20	13.5	8	15.5	53.5	23	24	52	34	12.5
SNG36	36	20	13.5	8	15.5	53.5	23	24	65	50	15.5
SNG42	42	20	13.5	8.6	16.1	53.5	23	24	92	70	22

# PRODUCT INFORMATION

## 磁性挂钩系列 Hook Magnet

钕铁硼磁性挂钩，配登山扣可旋转，电镀Nickel

Neodymium hook magnet, with carabiner-rotation, nickel coating

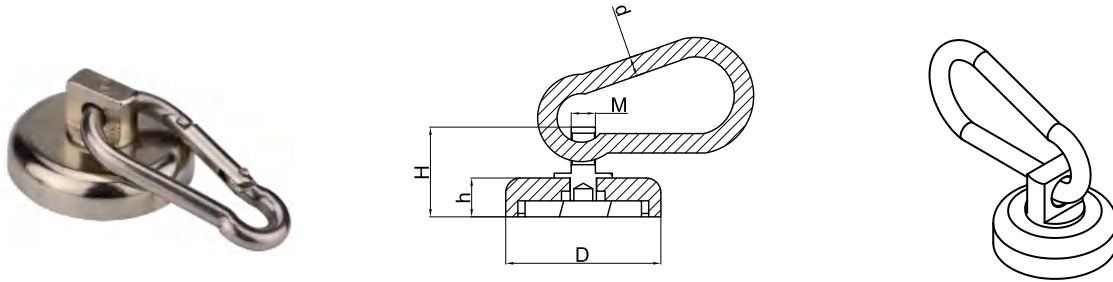

型号 Model	D (mm)	d (mm)	W (mm)	H (mm)	h (mm)	自重 Weight (g)	垂直拉脱力 V.P.O.Force (kg)	平行拉脱力 P.P.O.Force (kg)
SNL25	25	4	5	18.5	8	30	21	7.5
SNL32	32	4	5	18.5	8	47	34	12.5
SNL36	36	5	5	18.5	8	59	50	15.5
SNL42	42	5	5	19.1	8.6	115	70	22

## 磁性挂钩系列 Hook Magnet

钕铁硼磁性挂钩，开口挂钩，电镀Nickel

Neodymium hook magnet, with hook, nickel coating

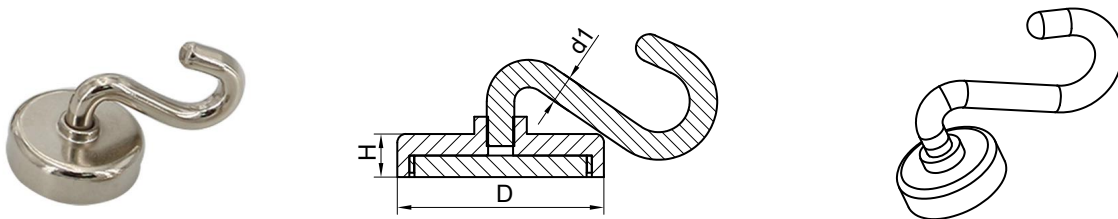

型号 Model	D (mm)	H (mm)	d1 (mm)	自重 Weight (g)	平行拉脱力 P.P.O.Force (kg)
SNS16	φ16	5	φ4	16	2.5
SNS25	φ20	8	φ5	37.5	6
SNS32	φ32	8	φ5.8	62.5	8

## 磁性挂钩系列 Hook Magnet

钕铁硼磁性挂钩，旋转挂钩，电镀Nickel

Neodymium hook magnet, with hook, nickel coating

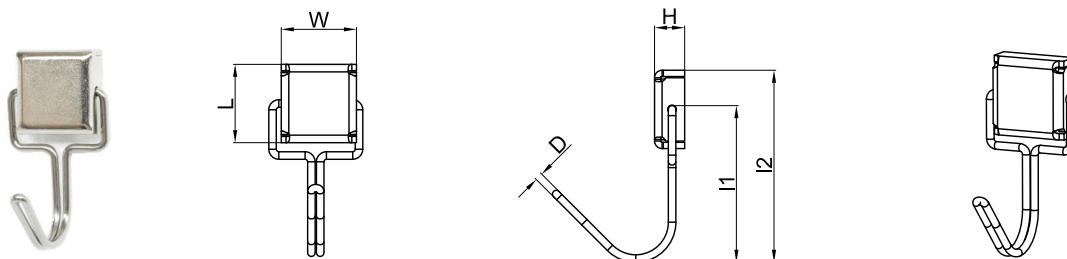

型号 Model	W (mm)	L (mm)	H (mm)	D (mm)	l1 (mm)	l2 (mm)	自重 Weight (g)	垂直拉脱力 V.P.O.Force (kg)	平行拉脱力 P.P.O.Force (kg)
SNY12	12	12.5	4.8	1.2	25	30.6	5.6	3	1.5

# PRODUCT INFORMATION

## 磁性挂钩系列 Hook Magnet

铁氧体磁性挂钩, 开口挂钩, 电镀Zinc

Ferrite hook magnet, with hook, zinc coating

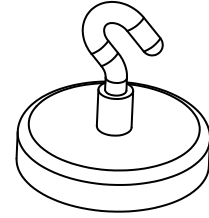
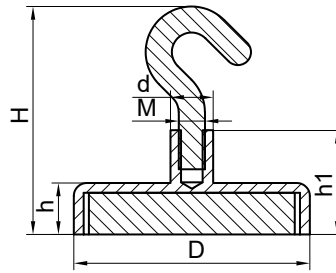

型号 Model	D (mm)	d (mm)	h (mm)	h1 (mm)	H (mm)	M	自重 Weight (g)	垂直拉脱力 V.P.O.Force (kg)
SFE25	25	6.5	7.4	15.5	37.5	M4	25	4.5
SFE32	32	6.5	6.9	15.6	37.6	M4	34	8.5
SFE36	36	6.5	7.9	16	38	M4	48	11
SFE40	40	7.5	7.9	17.9	45.4	M5	58	13
SFE47	47	7.5	9	18.5	46	M5	88	18
SFE50	50	7.5	9.9	19.4	46.9	M5	109	23
SFE57	57	7.5	10.4	19.9	47.4	M5	148	29
SFE63	63	10	14	25.5	55	M6	220	36
SFE80	80	10	18	31.2	67.7	M8	430	62

## 磁性挂钩系列 Hook Magnet

铁氧体磁性挂钩, 闭合挂钩, 电镀Zinc

Ferrite hook magnet, with hook, zinc coating

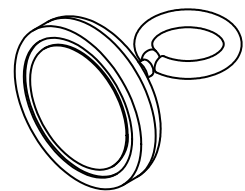
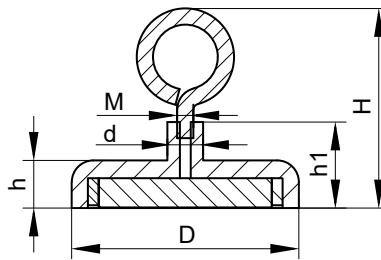

型号 Model	D (mm)	d (mm)	h (mm)	h1 (mm)	H (mm)	M	自重 Weight (g)	垂直拉脱力 V.P.O.Force (kg)
SFF25	25	6.5	7.4	15.5	37.5	M4	25	4.5
SFF32	32	6.5	6.9	15.6	37.6	M4	34	8.5
SFF36	36	6.5	7.9	16	38	M4	48	11
SFF40	40	7.5	7.9	17.9	45.4	M5	58	13
SFF47	47	7.5	9	18.5	46	M5	88	18
SFF50	50	7.5	9.9	19.4	46.9	M5	109	23
SFF57	57	7.5	10.4	19.9	47.4	M5	148	29
SFF63	63	10	14	25.5	55	M6	220	36
SFF80	80	10	18	31.2	67.7	M8	430	62

# PRODUCT INFORMATION

## 磁性挂钩系列 Hook Magnet

铁氧体磁钩，旋转挂钩，表面喷塑

Ferrite hook magnet, with swivel hook, powder coating

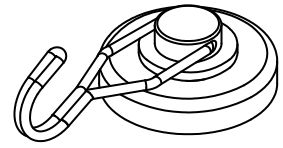
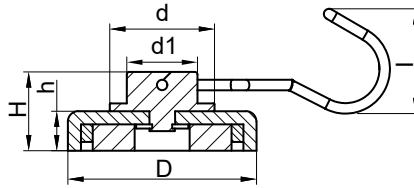

型号 Model	D (mm)	d (mm)	d1 (mm)	H (mm)	h (mm)	l (mm)	自重 Weight (g)	垂直拉脱力 V.P.O.Force (kg)	平行拉脱力 P.P.O.Force (kg)
SFG36	36	16	10.8	14.5	8.3	20	50	4.2	1.7
SFG52	52	16	10.8	14.5	8.3	20	80	7.4	2.5

## 磁性挂钩系列 Hook Magnet

钕铁硼包胶挂钩，底部包胶，塑料外壳

Neodymium rubber coated hook magnet, plastic case

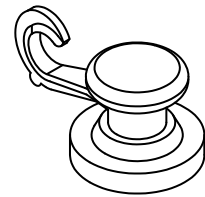
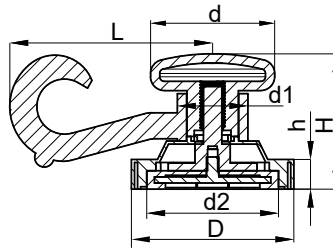

型号 Model	D (mm)	d (mm)	d1 (mm)	d2 (mm)	H (mm)	h (mm)	L (mm)	自重 Weight (g)	平行拉脱力 P.P.O.Force (kg)
STG43	53	35	22.5	43	43.5	10	65	55	2.5
STG66	68.2	35	22.5	66	51	13.8	65	139	10

## 磁性挂钩系列 Hook Magnet

钕铁硼包胶挂钩

Neodymium rubber coated hook magnet

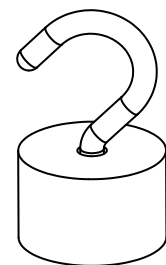
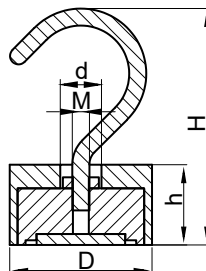

型号 Model	D (mm)	d (mm)	h (mm)	H (mm)	M	自重 Weight (g)	垂直拉脱力 V.P.O.Force (kg)
LSE45	45	13	25.5	75	M6	206	50

# PRODUCT INFORMATION

## 磁性挂钩系列 Hook Magnet

钕铁硼磁性挂钩, 开口挂钩, 电镀Nickel

Neodymium hook magnet, with hook, nickel coating

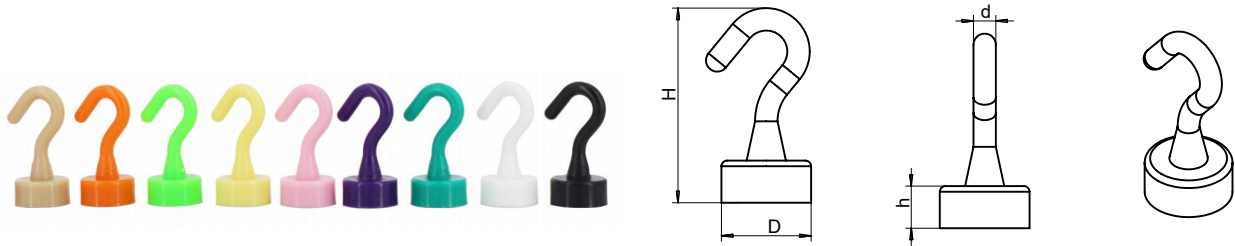

型号 Model	D (mm)	H (mm)	d (mm)	h (mm)	自重 Weight (g)	垂直拉脱力 V.P.O.Force (kg)
PNE16	16	34.7	4	7.5	5.8	6

## 对吸磁铁系列 Butt Magnet

钕铁硼对吸磁铁, 电镀Nickel

Neodymium butt magnet, nickel coating

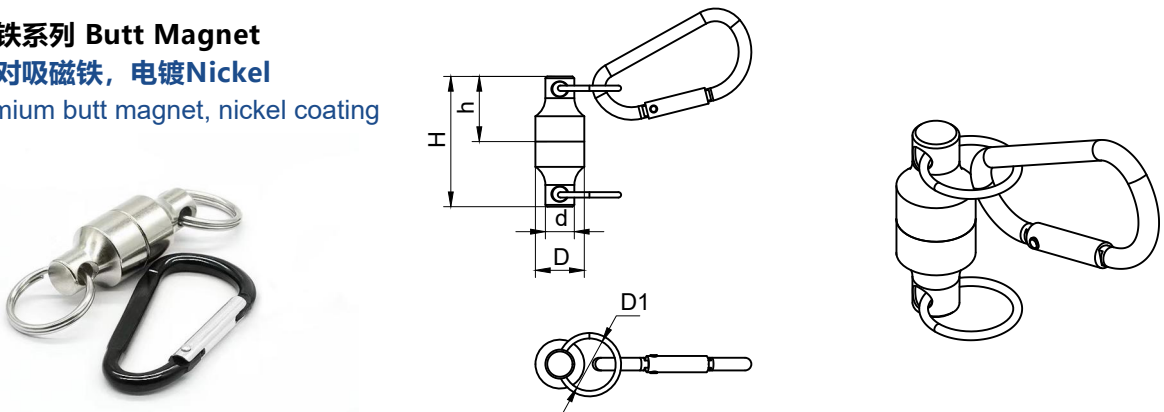

型号 Model	D (mm)	H (mm)	d (mm)	h (mm)	D1 (mm)	自重 Weight (g)	垂直拉脱力 V.P.O.Force (kg)
LNQ13.5	13.5	38	8	18	15	30	6

# PRODUCT INFORMATION

## 打捞磁铁系列 Fishing Magnet

钕铁硼打捞磁铁，配不锈钢吊环，电镀Nickel

Neodymium fishing magnet, with stainless steel hook, nickel coating

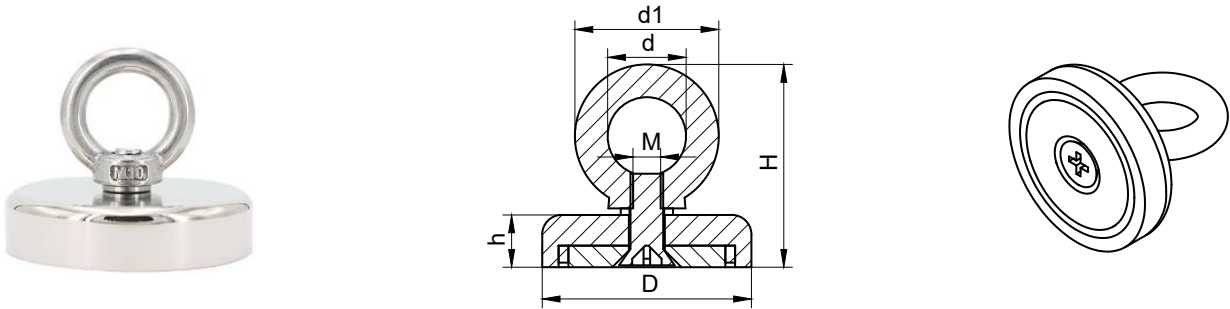

型号 Model	D (mm)	d (mm)	d1 (mm)	H (mm)	h (mm)	M	自重 Weight (g)	垂直拉脱力 V.P.O.Force (kg)
SNJ20	20	10	19	27	7	M4	27	11kg/25lb
SNJ25	25	12	22.5	32	8	M5	44	20kg/45lb
SNJ32	32	12	22.5	32	8	M5	59	32kg/70lb
SNJ36	36	15.5	27	38.5	8	M6	71	43kg/90lb
SNJ42	42	15.5	27	39.1	8.6	M6	98	65kg/140lb
LNJ48	48	19.5	34.5	47	11	M8	197	75kg/160lb
LNJ55	55	19.5	34.5	48	12	M8	278	95kg/200lb
LNJ60	60	19.5	34.5	51	15	M8	330	160kg/350lb
LNJ70	70	24.5	41	60.5	17	M10	608	210kg/450lb
LNJ75	75	24.5	41	61.5	18	M10	632	250kg/550lb
LNJ80	80	24.5	41	61.5	18	M10	821	280kg/600lb
LNJ90	90	24.5	41	61.5	18	M10	899	380kg/800lb
LNJ120	120	27.5	50	68.5	18	M12	1510	480kg/1000lb

## 打捞磁铁系列 Fishing Magnet

钕铁硼打捞磁铁，配不锈钢吊环，电镀Nickel

Neodymium fishing magnet, with stainless steel hook, nickel coating

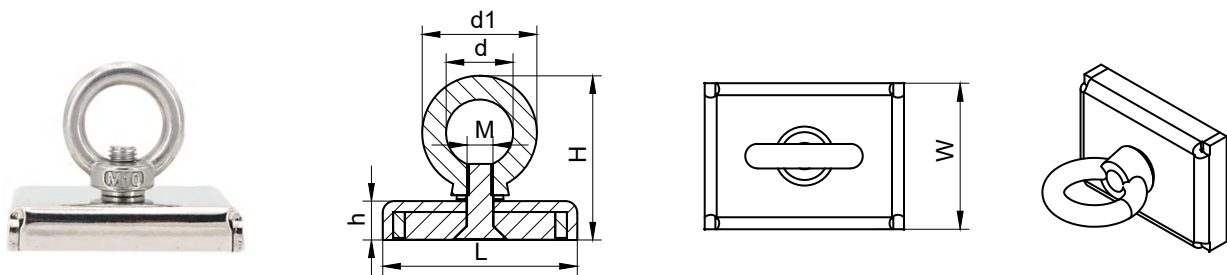

型号 Model	L (mm)	W (mm)	h (mm)	H (mm)	d (mm)	d1 (mm)	M	自重 Weight (g)	垂直拉脱力 V.P.O.Force (kg)
SNN75	75	55	15	59.5	24.5	41	M10	369	160kg/350lb

# PRODUCT INFORMATION

## 打捞磁铁系列 Fishing Magnet

钕铁硼打捞磁铁，配不锈钢吊环，电镀Nickel

Neodymium fishing magnet, with stainless steel hook, nickel coating

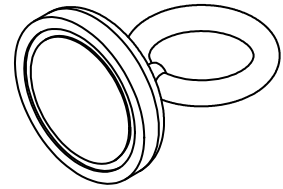
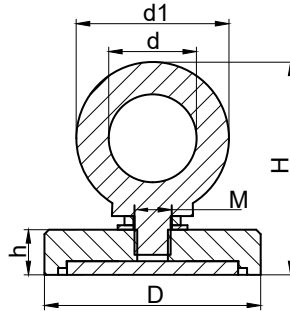

型号 Model	D (mm)	h (mm)	H (mm)	d (mm)	d1 (mm)	M	自重 Weight (g)	垂直拉脱力 V.P.O.Force (kg)
LNM48	48	10	53	19.5	34.5	M8	180	80kg/175lb
LNM60	60	12	55	19.5	34.5	M8	301	135kg/300lb
LNM67	67	12	69	25	41.5	M10	395	170kg/380lb
LNM75	75	15	69	25	41.5	M10	575	220kg/500lb
LNM94	94	18	69	25	41.5	M10	1022	300kg/650lb
LNM116	116	20	78	29	47	M12	1710	450kg/1000lb
LNM136	136	23	78	29	47	M12	2655	600kg/1350lb
LNM160	160	32	118	40	70	M20	5394	1000kg/2200lb
LNM200	200	37	144	50	88	M24	8867	1500kg/3300lb
LNM250	250	40	169	60	105	M30	16481	2000kg/4400lb
LNM320	320	50	219	70	120	M36	32460	3000kg/6600lb

## 打捞磁铁系列 Fishing Magnet

钕铁硼打捞磁铁，配不锈钢吊环，电镀Nickel

Neodymium fishing magnet, with stainless steel hook, nickel coating

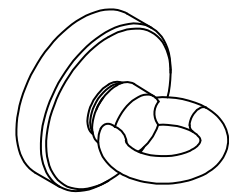
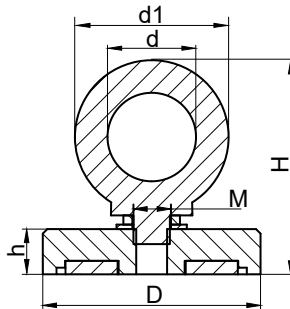

型号 Model	D (mm)	h (mm)	H (mm)	d (mm)	d1 (mm)	M	自重 Weight (g)	垂直拉脱力 V.P.O.Force (kg)
LNM48-1	48	10	48	19.5	34.5	M8	175	70kg/160lb
LNM60-1	60	12	50	19.5	34.5	M8	295	135kg/300lb
LNM67-1	67	12	60	25	41.5	M10	385	170kg/380lb
LNM75-1	75	15	62	25	41.5	M10	567	220kg/500lb
LNM94-1	94	18	67	25	41.5	M10	1012	300kg/650lb
LNM116-1	116	20	70	29	47	M12	1640	450kg/1000lb
LNM136-1	136	23	75	29	47	M12	2675	600kg/1350lb
LNM160-1	160	32	110	40	70	M20	5214	1000kg/2200lb
LNM200-1	200	37	135	50	88	M24	8889	1500kg/3300lb
LNM250-1	250	40	157	60	105	M30	16871	2000kg/4400lb
LNM320-1	320	50	198	70	120	M36	32633	3000kg/6600lb

# PRODUCT INFORMATION

## 打捞磁铁系列 Fishing Magnet

钕铁硼打捞磁铁，配不锈钢吊环，电镀Nickel

Neodymium fishing magnet, with stainless steel hook, nickel coating

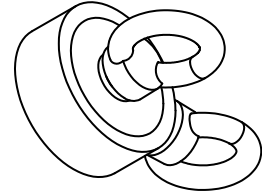
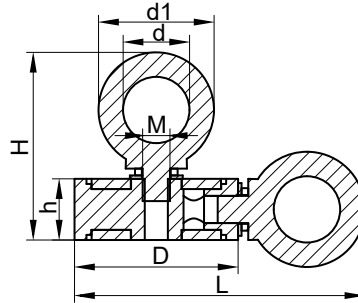

型号 Model	D (mm)	h (mm)	H (mm)	L (mm)	d (mm)	d1 (mm)	M1 M2	自重 Weight (g)	垂直拉脱力 V.P.O.Force (kg)
LNM48-2	48	18	58	83	19.5	34.5	M8	211	70kg/160lb
LNM60-2	60	22	66	95	19.5	34.5	M8	551	135kg/300lb
LNM67-2	67	25	75	102	25	41.5	M10	795	170kg/380lb
LNM75-2	75	25	77	110	25	41.5	M10	945	220kg/500lb
LNM94-2	94	28	85	129	25	41.5	M10	1600	300kg/650lb
LNM116-2	116	32	92	160	29	47	M12	2745	450kg/1000lb
LNM136-2	136	34	92	190	29	47	M12	3580	600kg/1350lb

## 打捞磁铁系列 Fishing Magnet

钕铁硼打捞磁铁，配不锈钢吊环，电镀Nickel

Neodymium fishing magnet, with stainless steel hook, nickel coating

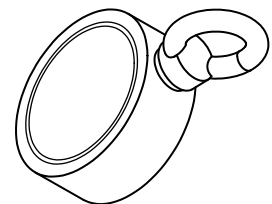
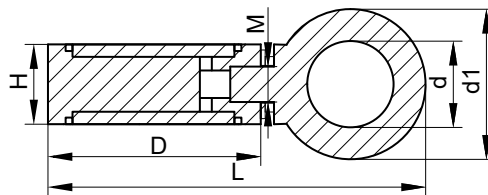

型号 Model	D (mm)	H (mm)	L (mm)	d (mm)	d1 (mm)	M	自重 Weight (g)	垂直拉脱力 V.P.O.Force (kg)
LNM48-3	48	18	86	20	35	M8	280	80kg/175lb
LNM60-3	60	22	98	20	35	M8	420	135kg/300lb
LNM67-3	67	25	111	25	42	M10	720	170kg/380lb
LNM75-3	75	25	119	25	42	M10	885	220kg/500lb
LNM94-3	94	28	138	25	42	M10	1540	300kg/650lb
LNM116-3	116	32	167	29	47	M12	2435	450kg/1000lb
LNM136-3	136	34	187	29	47	M12	3355	600kg/1350lb

# PRODUCT INFORMATION

## 打捞磁铁系列 Fishing Magnet

钕铁硼打捞磁铁，配不锈钢吊环，电镀Nickel

Neodymium fishing magnet, with stainless steel hook, nickel coating

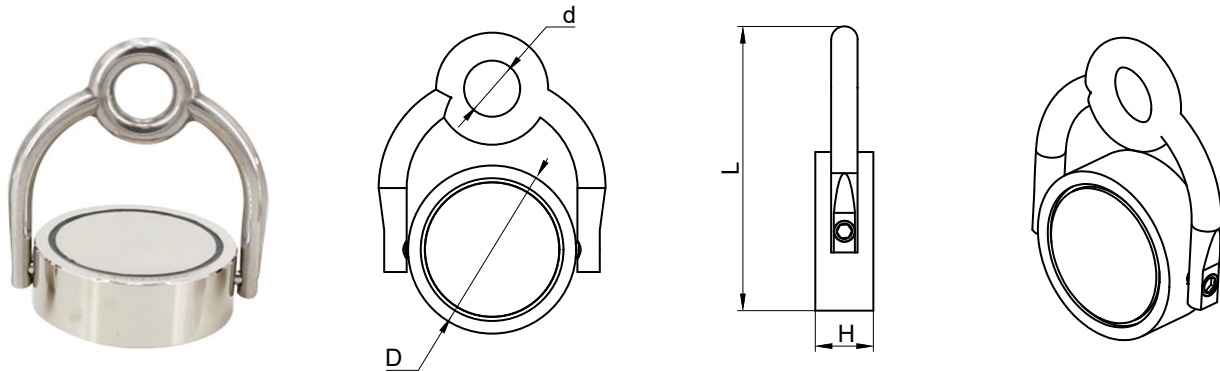

型号 Model	D (mm)	H (mm)	d (mm)	L (mm)	自重 Weight (g)	垂直拉脱力 V.P.O.Force (kg)
LNM60-4	60	22	20	107.5	610	135kg/300lb
LNM75-4	75	25	20	127.5	1000	220kg/500lb

# PRODUCT INFORMATION

## 包胶磁铁系列 Rubber Coated Magnet

### 钕铁硼包胶磁铁，沉头孔

Neodymium rubber coated magnet, with counter bore

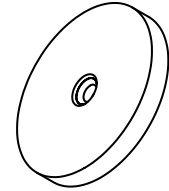
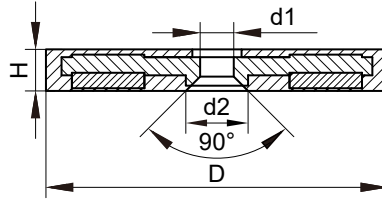
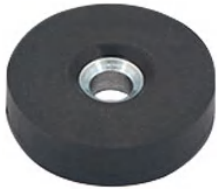

型号 Model	D (mm)	d1 (mm)	d2 (mm)	H (mm)	自重 Weight (g)	垂直拉脱力 V.P.O.Force (kg)
STA22	22	4.5	8.6	6	8	2
STA34	34	4.5	8.5	8	20	4
STA43	43	4.5	8.6	7	27	9

## 包胶磁铁系列 Rubber Coated Magnet

### 钕铁硼包胶磁铁，直孔

Neodymium rubber coated magnet, with bore

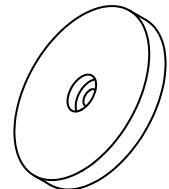
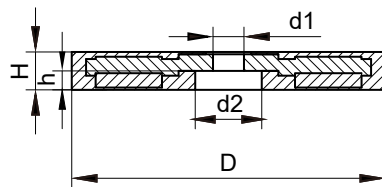

型号 Model	D (mm)	d1 (mm)	d2 (mm)	h (mm)	H (mm)	自重 Weight (g)	垂直拉脱力 V.P.O.Force (kg)
STB22	22	4.5	8.6	3	6	8	2
STB34	34	4.5	9.5	4	8	20	6
STB43	43	4.5	9.5	3	7	27	9

# PRODUCT INFORMATION

## 包胶磁铁系列 Rubber Coated Magnet

### 钕铁硼包胶磁铁，外螺纹

Neodymium rubber coated magnet, with external thread

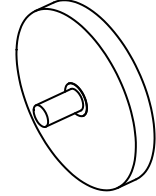
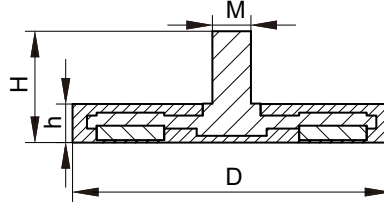

型号 Model	D (mm)	h (mm)	H (mm)	M	自重 Weight (g)	垂直拉脱力 V.P.O.Force (kg)
STC22	22	6	12.5	M4	14	4.5
STC34	34	6	14.5	M4	25	6
STC43	43	6	21	M6	32	8
STC66	66	8	23	M8	107	20
STC88	88	8.5	24.5	M8	193	42

## 包胶磁铁系列 Rubber Coated Magnet

### 钕铁硼包胶磁铁，内螺纹

Neodymium rubber coated magnet, with screwed bush

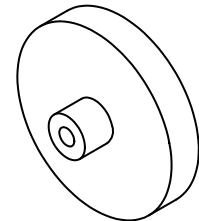
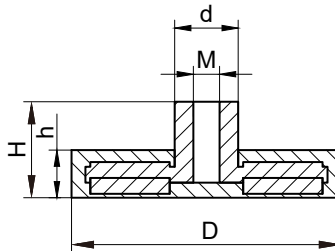

型号 Model	D (mm)	d (mm)	h (mm)	H (mm)	M	自重 Weight (g)	垂直拉脱力 V.P.O.Force (kg)
STD22	22	8	6	11.5	M4	12	4.5
STD34	34	8	6	12	M4	22	6
STD43	43	8	6	12	M4	34	8
STD66	66	12	8	14.2	M5	104	20
STD88	88	12	8.5	15.8	M8	200	42

# PRODUCT INFORMATION

## 包胶磁铁系列 Rubber Coated Magnet

### 钕铁硼包胶磁铁，平螺纹

Neodymium rubber coated magnet, with internal thread

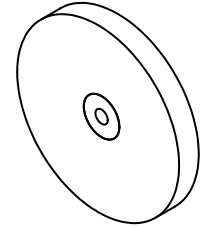
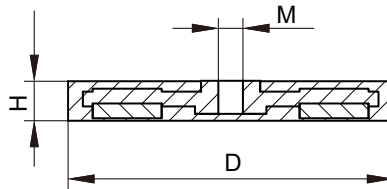

型号 Model	D (mm)	H (mm)	M	自重 Weight (g)	垂直拉脱力 V.P.O.Force (kg)
STP22	22	6	M4	11	3
STP34	34	6	M4	20	6
STP43	43	6	M4	29	8
STP66	66	8	M6	100	20
STP88	88	8.5	M8	186	42

## 包胶磁铁系列 Rubber Coated Magnet

### 钕铁硼包胶磁铁，开口挂钩

Neodymium rubber coated magnet, with hook

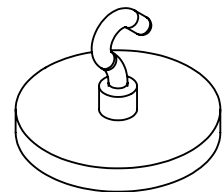
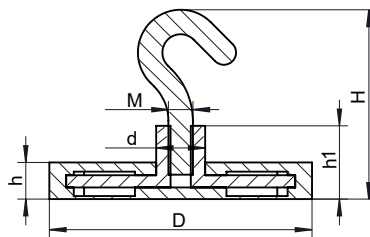

型号 Model	D (mm)	d (mm)	H (mm)	h (mm)	h1 (mm)	M	自重 Weight (g)	垂直拉脱力 V.P.O.Force (kg)
STD22-E	22	8	34	6	11.5	M4	15	5
STD34-E	34	8	35	6	14	M4	25	6
STD43-E	43	8	32	6	12	M4	36	8
STD66-E	66	12	38	8	14.2	M5	110	20
STD88-E	88	12	51	8.5	15.8	M8	223	42

# PRODUCT INFORMATION

## 包胶磁铁系列 Rubber Coated Magnet

### 钕铁硼包胶磁铁，配吊环

Neodymium rubber coated magnet, with hook

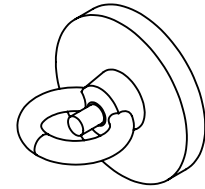
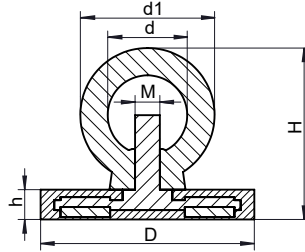

型号 Model	D (mm)	d (mm)	d1 (mm)	H (mm)	h (mm)	M	自重 Weight (g)	垂直拉脱力 V.P.O.Force (kg)
STC43-J	43	15.5	27	34	6	M6	49	8
STC66-J	66	19.5	34.5	42	8	M8	137	20
STC88-J	88	19.5	34.5	42.5	8.5	M8	223	42

## 包胶磁铁系列 Rubber Coated Magnet

### 钕铁硼包胶磁铁，配重型挂钩

Neodymium rubber coated magnet, with heavy hook

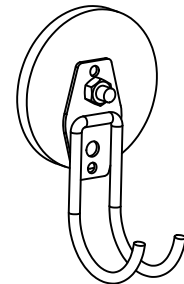
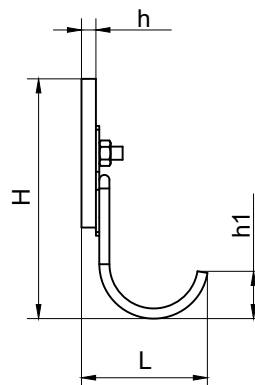
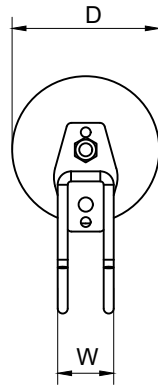

型号 Model	D (mm)	W (mm)	L (mm)	H (mm)	h (mm)	h1 (mm)	自重 Weight (g)	平行拉脱力 P.P.O.Force (kg)
STC43-C	43	37	73	123	6	29	132	5
STC66-C	66	37	75	134	8	29	207	14
STC88-C	88	37	75.5	145	8.5	29	296	25

# PRODUCT INFORMATION

## 包胶磁铁系列 Rubber Coated Magnet

### 钕铁硼包胶磁铁，配重型挂钩

Neodymium rubber coated magnet, with heavy hook

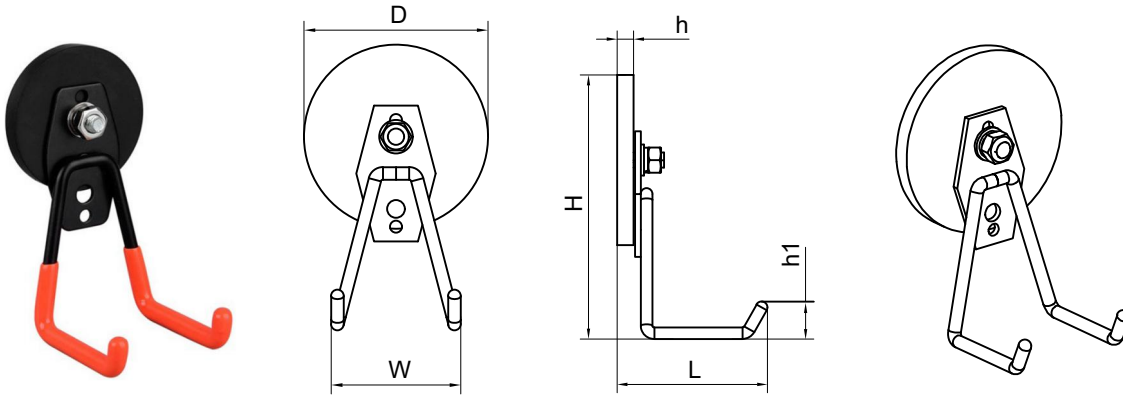

型号 Model	D (mm)	W (mm)	L (mm)	H (mm)	h (mm)	h1 (mm)	自重 Weight (g)	平行拉脱力 P.P.O.Force (kg)
STC43-L	43	62	75	120	6	23	140	5
STC66-L	66	62	77	130	8	23	215	14
STC88-L	88	62	77.5	142	8.5	23	300	25

## 包胶磁铁系列 Rubber Coated Magnet

### 钕铁硼包胶磁铁，配杯架

Neodymium rubber coated magnet, with cup holder

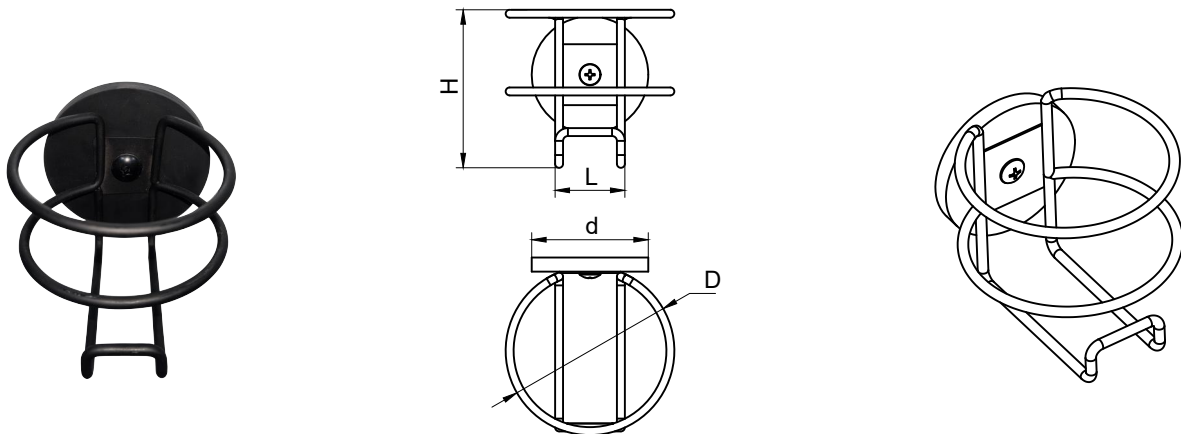

型号 Model	D (mm)	d (mm)	L (mm)	H (mm)	自重 Weight (g)	平行拉脱力 P.P.O.Force (kg)
STP66-G	91	66	35	85	215	8
STP88-G	91	88	35	85	295	18

# PRODUCT INFORMATION

## 包胶磁铁系列 Rubber Coated Magnet

### 钕铁硼包胶磁铁，配盆架

Neodymium rubber coated magnet, with basin holder

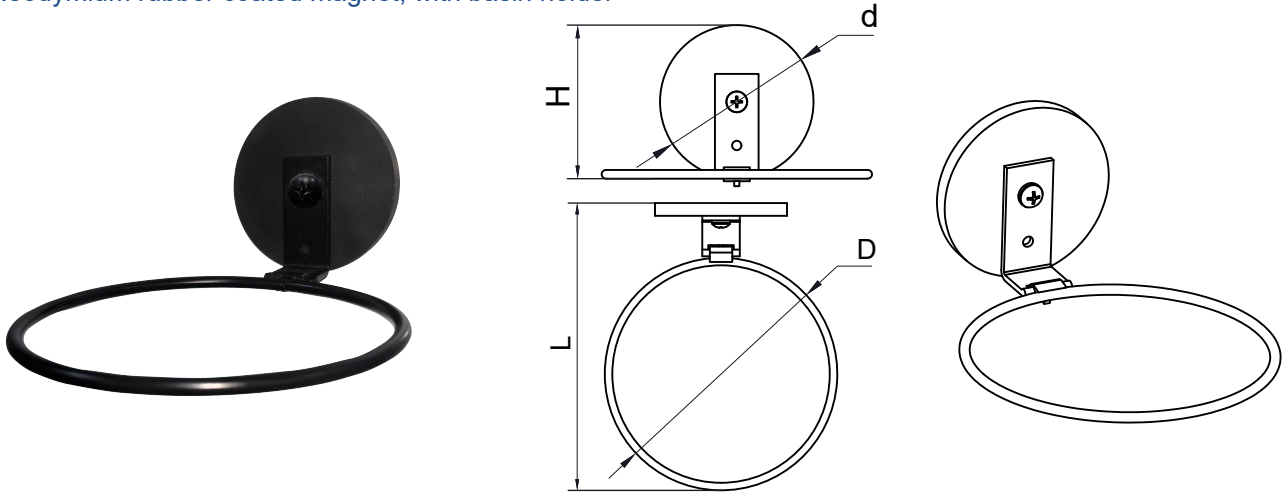

型号 Model	D (mm)	d (mm)	L (mm)	H (mm)	自重 Weight (g)	平行拉脱力 P.P.O.Force (kg)
STP66-O	110	66	150	77	215	6
STP88-O	150	88	190	88	350	12

## 包胶磁铁系列 Rubber Coated Magnet

### 钕铁硼包胶磁铁，配绑带

Neodymium rubber coated magnet, with webbing

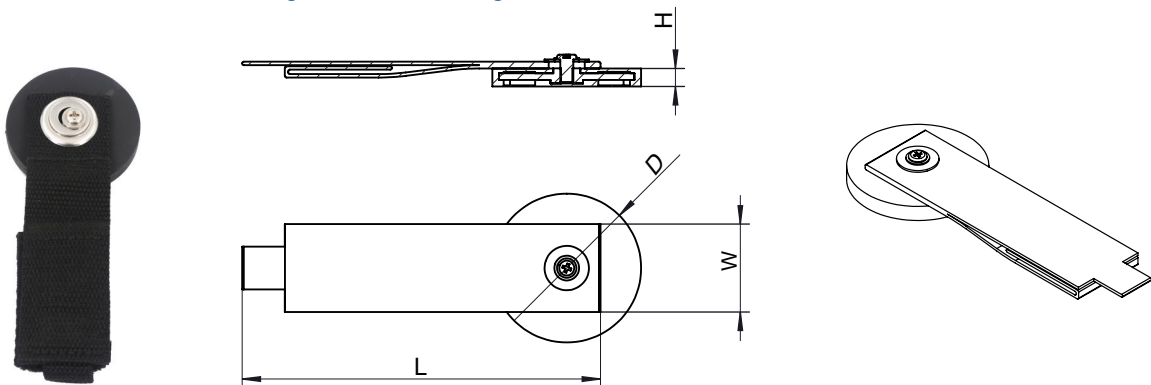

型号 Model	D (mm)	W (mm)	L (mm)	H (mm)	自重 Weight (g)	平行拉脱力 P.P.O.Force (kg)
STP43-I	43	25	118	6	39	5
STP66-I	66	35	159	8	118	14
STP88-I	88	50	188	8.5	205	25

# PRODUCT INFORMATION

## 图钉磁铁系列 Pin Magnet

钕铁硼磁图钉, 聚丙烯塑料外壳

Neodymium pin magnet, polypropylene plastic case

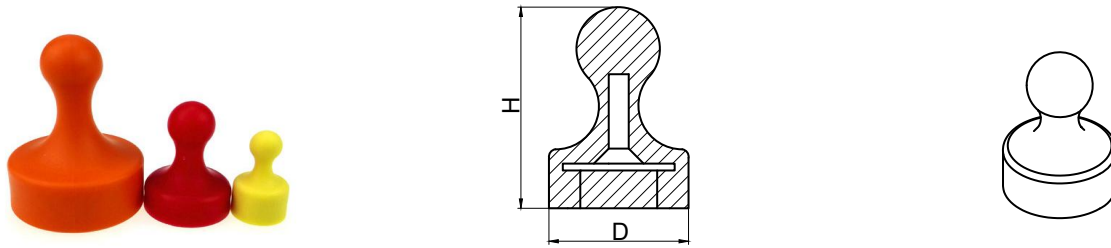

型号 Model	D (mm)	H (mm)	自重 Weight (g)	A4纸张数 on 白板 A4 Paper on Whiteboard (pcs)
PNR12	12	20	3.5	18
PNR19	19	25	7	24
PNR29	29	38	22	30

## 图钉磁铁系列 Pin Magnet

钕铁硼磁图钉, 亚克力塑料外壳

Neodymium pin magnet, acrylic plastic case

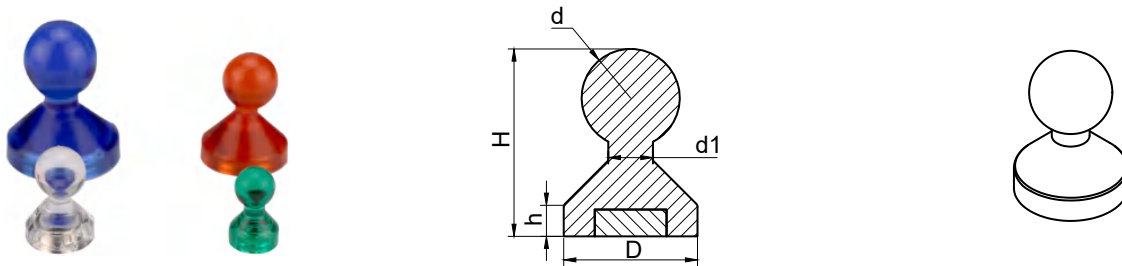

型号 Model	D (mm)	d (mm)	d1 (mm)	H (mm)	h (mm)	自重 Weight (g)	A4纸张数 on 白板 A4 Paper on Whiteboard (pcs)
PNR11	11	9	4.2	17	3.5	1.4	11
PNR15	15	11	5	20	3.5	2.8	15

## 图钉磁铁系列 Pin Magnet

钕铁硼磁图钉, ABS塑料外壳

Neodymium pin magnet, ABS plastic case

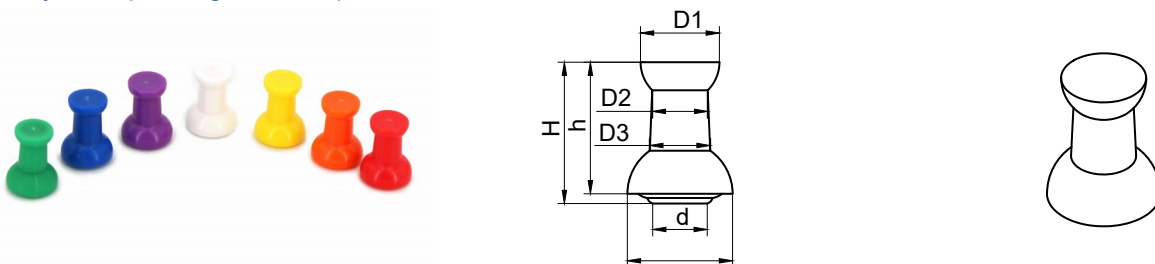

型号 Model	D (mm)	D1 (mm)	D2 (mm)	D3 (mm)	d (mm)	H (mm)	h (mm)	自重 Weight (g)	A4纸张数 on 白板 A4 Paper on Whiteboard (pcs)
PNR10.8	10.8	8.1	5.7	6.2	5.5	14.5	13.5	1	11

# PRODUCT INFORMATION

## 图钉磁铁系列 Pin Magnet

### 钕铁硼磁图钉

Neodymium pin magnet

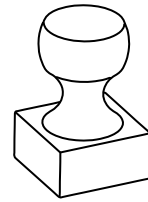
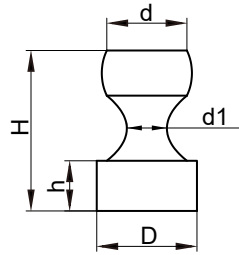

型号 Model	D (mm)	d (mm)	d1 (mm)	H (mm)	h (mm)	自重 Weight (g)	A4纸张数on白板 A4 Paper on Whiteboard (pcs)
四方-10*16-镀镍	10	8	9	16	5	7	11
四方-10*16-彩色	10	8	9	16	5	7	11

## 图钉磁铁系列 Pin Magnet

### 钕铁硼磁图钉

Neodymium pin magnet

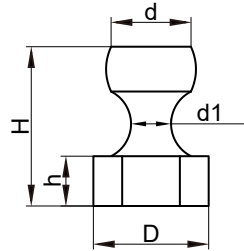

型号 Model	D (mm)	d (mm)	d1 (mm)	H (mm)	h (mm)	自重 Weight (g)	A4纸张数on白板 A4 Paper on Whiteboard (pcs)
六角-10*16-镀镍	10	9	4	16	5	6	11
六角-10*16-彩色	10	9	4	16	5	6	11

## 图钉磁铁系列 Pin Magnet

### 钕铁硼磁图钉

Neodymium pin magnet

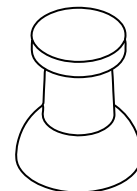
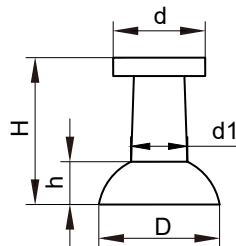

型号 Model	D (mm)	d (mm)	d1 (mm)	H (mm)	h (mm)	自重 Weight (g)	A4纸张数on白板 A4 Paper on Whiteboard (pcs)
工字-11*13-镀镍	11	8	9	13	4	4	11
工字-11*13-彩色	11	8	9	13	4	4	11

# PRODUCT INFORMATION

## 图钉磁铁系列 Pin Magnet

钕铁硼磁图钉, 电镀Nickel

Neodymium pin magnet, nickel coating

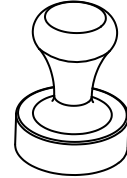
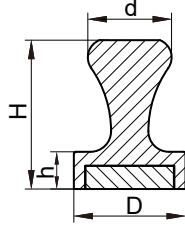

型号 Model	D (mm)	d (mm)	H (mm)	h (mm)	自重 Weight (g)	A4纸张数 on 白板 A4 Paper on Whiteboard (pcs)
LNR12	12	9	16	4	9.6	12
LNR12E	12	9	16	4	9.6	12
LNR16	16	11	20	5	16	16
LNR20	20	13	25	7	30	19
LNR25	25	18	30	7	53	23

## 图钉磁铁系列 Pin Magnet

钕铁硼磁图钉, 电镀Nickel

Neodymium pin magnet, nickel coating

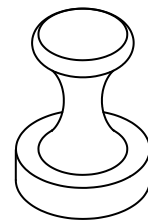
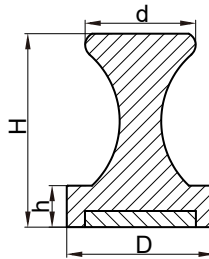

型号 Model	D (mm)	d (mm)	H (mm)	h (mm)	自重 Weight (g)	平行拉脱力 P.P.O.Force (kg)
LNR32	32	24	42	9	103	8
LNR36	36	26	46	10	140	10
LNR42	42	35	52	10	233	15

# PRODUCT INFORMATION

## 图钉磁铁系列 Pin Magnet

钕铁硼磁扣, 聚丙烯塑料外壳

Neodymium pin magnet, polypropylene plastic case

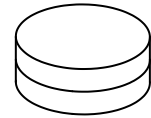
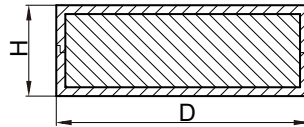

型号 Model	D (mm)	H (mm)	自重 Weight (g)	A4纸张数 on 白板 A4 Paper on Whiteboard (pcs)
PNR12.7*6.35	12.7	6.35	4	11

## 图钉磁铁系列 Pin Magnet

钕铁硼波纹磁扣, 电镀Nickel

Neodymium pin magnet, nickel coating

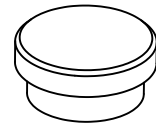
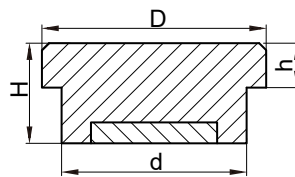

型号 Model	D (mm)	d (mm)	H (mm)	h (mm)	自重 Weight (g)	A4纸张数 on 白板 A4 Paper on Whiteboard (pcs)
LNR16-O	16	13.3	7.2	3.2	9	11
LNR22-O	22	18	9	3	21	13
LNR25-O	25	21	9	3	27	15
LNR30-O	30	27	9	3	43	17

# PRODUCT INFORMATION

## 磁性夹系列 Magnetic Clip

铁氧体磁性夹子, 电镀铬

Ferrite clip magnet, chromium coating

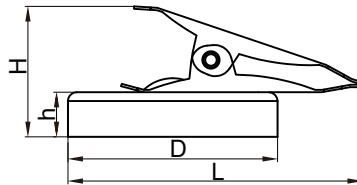

型号 Model	D (mm)	h (mm)	H (mm)	L (mm)	自重 Weight (g)	A4纸张数 on 白板 A4 Paper on Whiteboard (pcs)
SFK36	36	7.4	23.2	50.5	45	140

## 磁性夹系列 Magnetic Clip

钕铁硼/铁氧体磁性夹子, 电镀铬

Neodymium/ Ferrite clip magnet, chromium coating

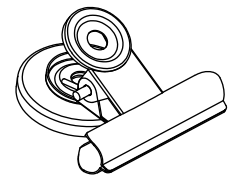
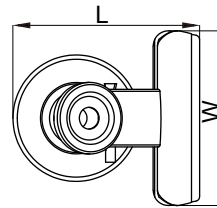
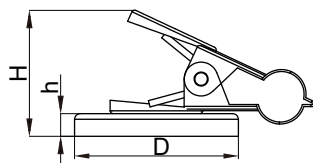

型号 Model	L (mm)	W (mm)	H (mm)	h (mm)	D (mm)	自重 Weight (g)	A4纸张数 on 白板 A4 Paper on Whiteboard (pcs)
SFK31	38	30	22	3.5	28	16	60
SFK38	42	40	26.5	4.2	28	20	80
SFK50	50	51	32.5	4.2	28	23	100

## 磁性夹系列 Magnetic Clip

铁氧体磁性夹子, 电镀铬

Ferrite clip magnet, chromium coating

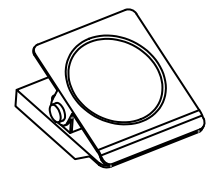
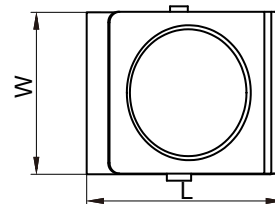
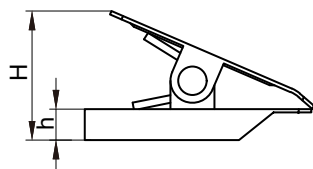

型号 Model	L (mm)	W (mm)	H (mm)	h (mm)	自重 Weight (g)	A4纸张数 on 白板 A4 Paper on Whiteboard (pcs)
SFK30	31	36	21	5	25	15
SFK38-1	38	46.5	25	5.5	45	20
SFK45	46	52	26.5	5.5	67	30
SFK54	67.5	55	34	6	87	40

# PRODUCT INFORMATION

## 胸牌磁铁系列 Name Badge Magnet

### 磁性胸牌

### Name Badge Magnet

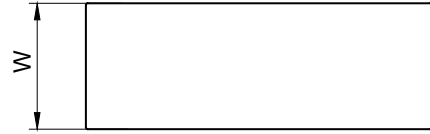
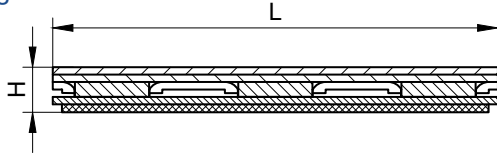

型号 Model	产品实物图 Product picture	L (mm)	W (mm)	H (mm)	磁铁数量 Magnet quantity	产品框架图 Frame diagram	自重 Weight (g)
LSBM-1		45.5	13	6.3	3	GREEN MAGNET CAUTION-MAGNETIC DEVICE DO NOT USE WITH PACEMAKER	12
LSBM-2		45	13	6.3	3	CAUTION - MAGNETIC DEVICE DO NOT USE WITH PACEMAKER	12
LSBM-3		45.5	13	6.3	3	BH1-4 MAG-SECURE	12
LSBM-4		32.5	12.5	6.3	2	CAUTION MAGNETIC	8
LSBM-5		45	13	5.3	2	CAUTION MAGNETIC	12
LSBM-6		46	13.3	6.5	2	CAUTION MAGNETIC	12
LSBM-7		46.5	14.7	6.3	2	Caution Magnetic Device	12
LSBM-8		45	13	6.3	2	CAUTION - MAGNETIC DEVICE DO NOT USE WITH PACEMAKER	12
LSBM-9		D17	/	5	1		4
LSBM-10		D20		5	1		6

# PRODUCT INFORMATION

## 磁性工具系列 Magnetic Tools

### 圆筒磁性捡拾器

Cylindrical magnetic pick up tool

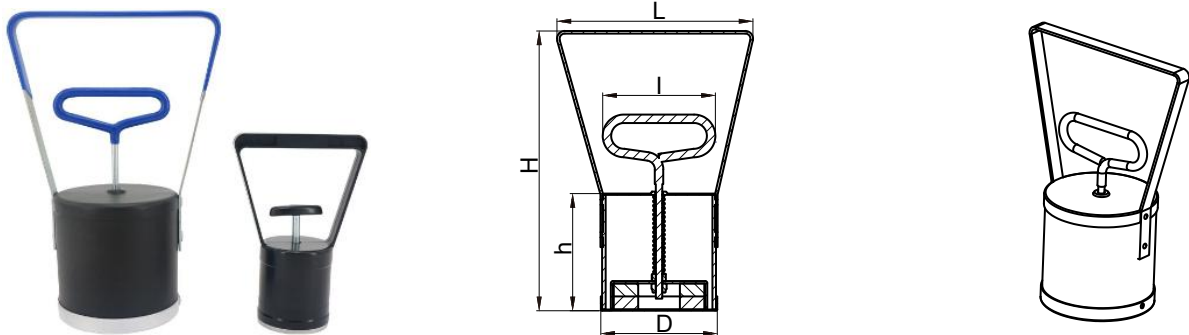

型号 Model	D (mm)	L (mm)	l (mm)	h (mm)	H (mm)	自重 Weight (g)
MC89	89	148	81	90	210	645
MC53	53	95	40	61	138	98

## 磁性工具系列 Magnetic Tools

### 方形磁性捡拾器

Square magnetic pickup tool

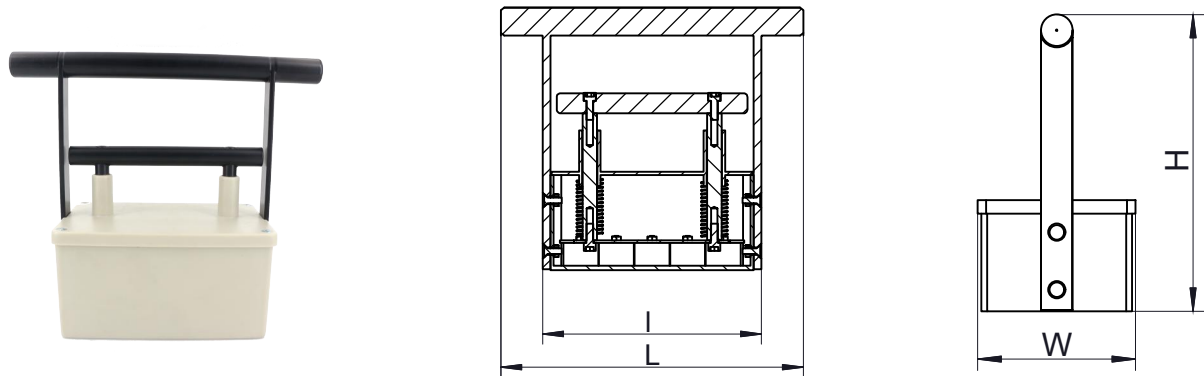

型号 Model	L (mm)	l (mm)	W (mm)	H (mm)	自重 Weight (g)
MR155	238	155	100	210	1420

# PRODUCT INFORMATION

## 磁性工具系列 Magnetic Tools

### 磁性工具架, 单面磁力, 铁外壳

Magnetic tool holder, single sided magnet, iron shell

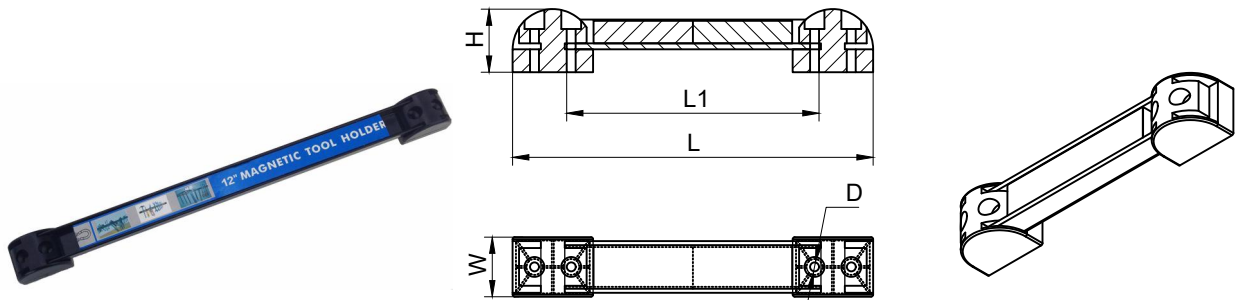

型号 Model	L (mm)	L1 (mm)	H (mm)	W (mm)	D (mm)	自重 Weight (g)
MTH8"	250	8"	28	24	4.5	300
MTH12"	350	12"	28	24	4.5	500
MTH18"	500	18"	28	24	4.5	760
MTH24"	650	24"	28	24	4.5	1020

## 磁性工具系列 Magnetic Tools

### 磁性工具架, 双面磁力, 铁外壳

Magnetic tool holder, double sided magnet, iron shell

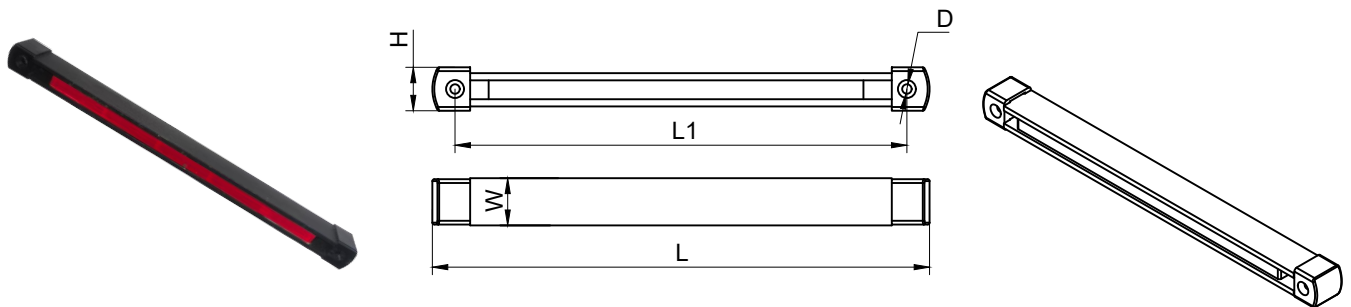

型号 Model	L (mm)	L1 (mm)	H (mm)	W (mm)	D (mm)	自重 Weight (g)
MTH12"-2	304.5	280.8	23	18	5	680
MTH18"-2	457.2	430.2	23	18	5	1080
MTH24"-2	609.6	585.6	23	18	5	1480

# PRODUCT INFORMATION

## 磁性工具系列 Magnetic Tools

### 磁性工具架, 铝合金外壳

Magnetic tool holder, aluminum alloy shell

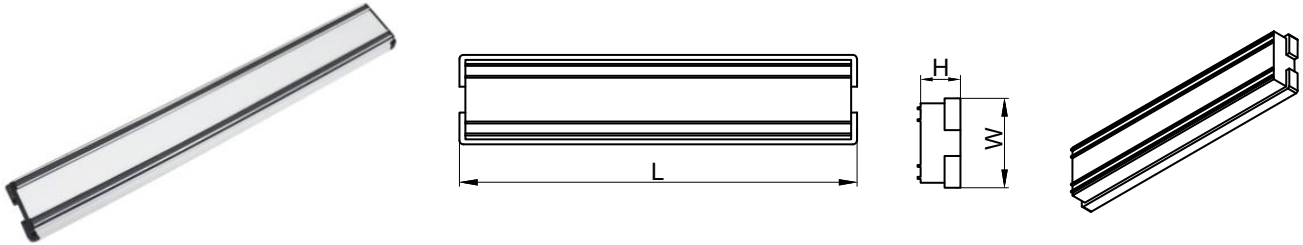

型号 Model	L (mm)	H (mm)	W (mm)	自重 Weight (g)
MTH315	315	20	45	367
MTH365	365	20	45	310
MTH415	415	20	45	336
MTH465	465	20	45	380

## 磁性工具系列 Magnetic Tools

### 磁性工具架, 塑料外壳

Magnetic tool holder, plastic shell

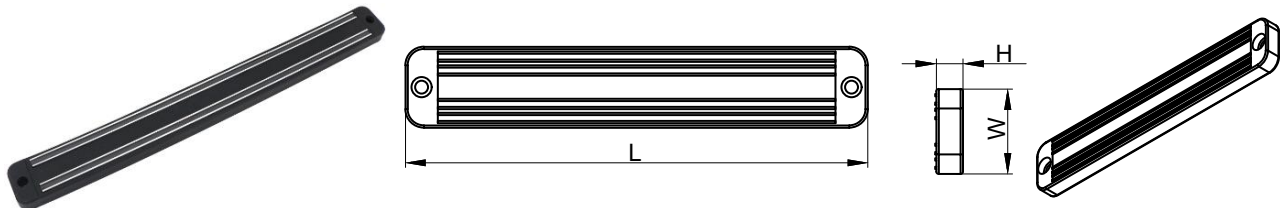

型号 Model	L (mm)	H (mm)	W (mm)	自重 Weight (g)
MTH200-1	200	11	35	152
MTH300-1	300	11	35	216
MTH333-1	333	11	35	236
MTH486-1	486	15	35	428

# PRODUCT INFORMATION

## 磁性工具系列 Magnetic Tools

### 磁性工具架, 塑料外壳

Magnetic tool holder, plastic shell

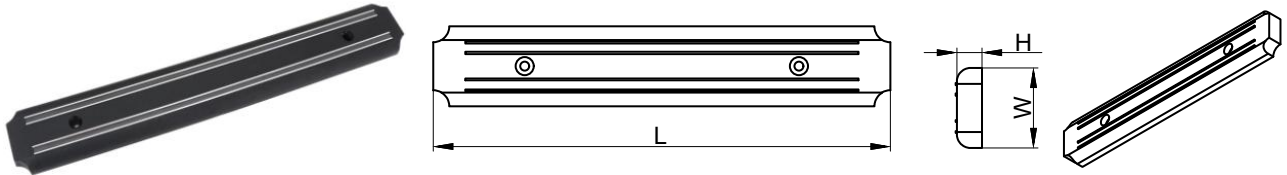

型号 Model	L (mm)	H (mm)	W (mm)	自重 Weight (g)
MTH200-2	200	13	48	146
MTH330-2	330	13	48	272
MTH380-2	380	13	48	320
MTH555-2	555	13	48	495

# PRODUCT INFORMATION

## 磁性工具系列 Magnetic Tools

### 磁性焊接固定器

Magnetic welding holder

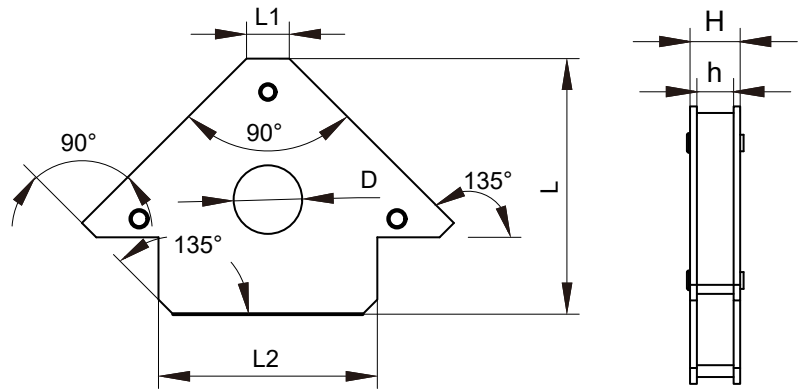

型号 Model	L (mm)	H (mm)	h (mm)	L1 (mm)	L2 (mm)	D (mm)	自重 Weight (g)	垂直拉脱力 V.P.O.Force (Lb)
MWH25	83	14	10	13	71	/	295	25
MWH50	102	16	12	28	92	29	500	50
MWH75	122	24	20	35	113	46	900	75

## 磁性工具系列 Magnetic Tools

### 磁性焊接固定器

Magnetic welding holder

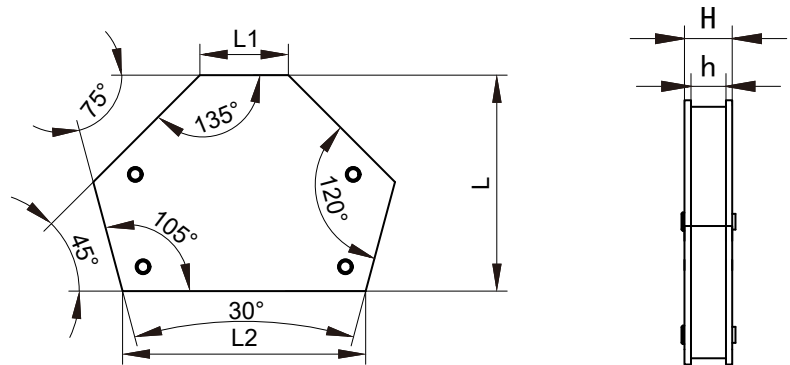

型号 Model	L (mm)	H (mm)	h (mm)	L1 (mm)	L2 (mm)	自重 Weight (g)	垂直拉脱力 V.P.O.Force (Lb)
MWH25-1	70	14	10	34	84	290	25
MWH50-1	90	16	12	43	88	490	50
MWH75-1	110	24	20	55	110	880	75

# PRODUCT INFORMATION

## 磁性工具系列 Magnetic Tools

### 磁性焊接固定器

Magnetic welding holder

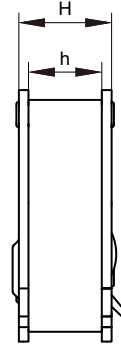
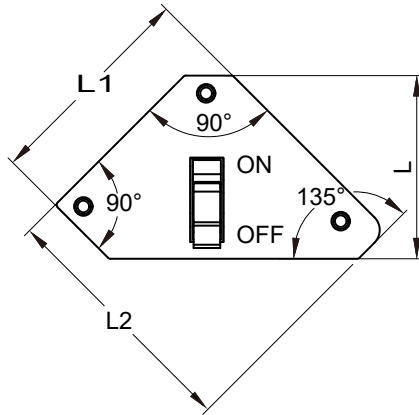

型号 Model	L (mm)	L1 (mm)	L2 (mm)	H (mm)	h (mm)	自重 Weight (g)	垂直拉脱力 V.P.O.Force (Lb)
MWH35-2	86	95	110	26	21	469	35
MWH55-2	118	103	150	33	28	983	55

## 磁性工具系列 Magnetic Tools

### 磁性焊接固定器

Magnetic welding holder

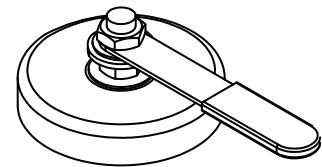
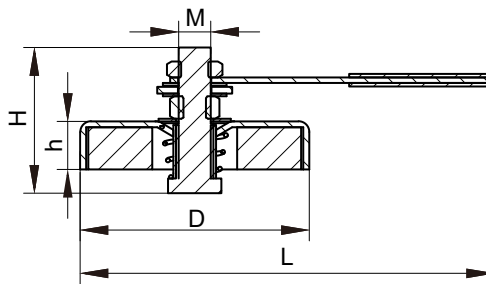

型号 Model	D (mm)	H (mm)	h (mm)	L (mm)	M	自重 Weight (g)	垂直拉脱力 V.P.O.Force (Lb)
MWHD55	55	41	12	140	M8	185	16
MWHD85	85	55	18	153	M12	585	65

# PRODUCT INFORMATION

## 磁性工具系列 Magnetic Tools

### 磁性焊接固定器

Magnetic welding holder

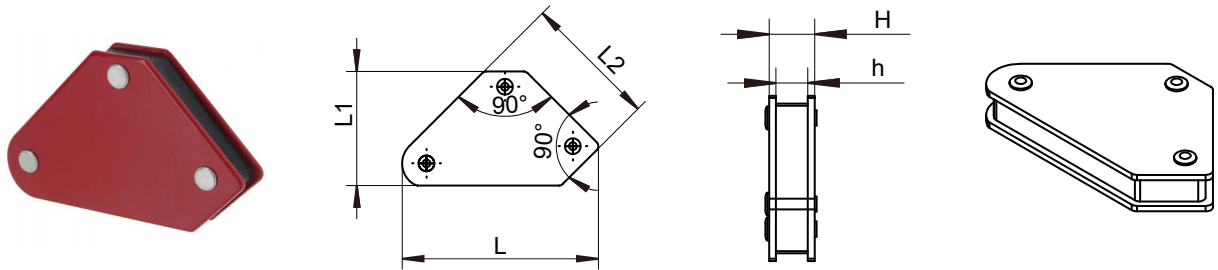

型号 Model	L (mm)	L1 (mm)	L2 (mm)	H (mm)	h (mm)	自重 Weight (g)	垂直拉脱力 V.P.O.Force (Lb)
TH1011	73	43	51	12	7.5	104	5

## 磁性工具系列 Magnetic Tools

### 磁性焊接固定器

Magnetic welding holder

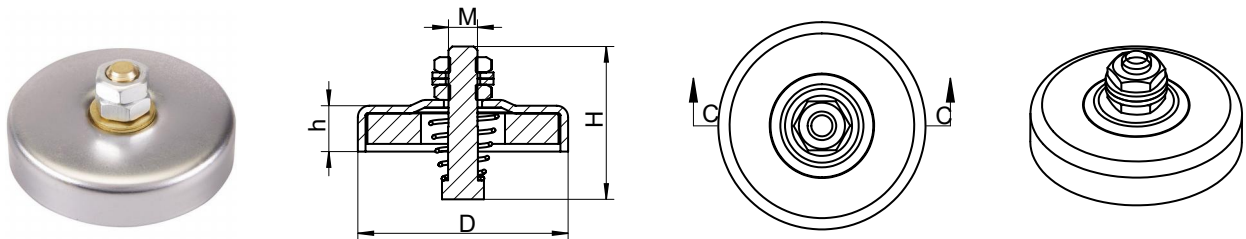

型号 Model	D (mm)	H (mm)	h (mm)	M	自重 Weight (g)	垂直拉脱力 V.P.O.Force (Lb)
TH1010	55	40	12	M8	148	16

# PRODUCT INFORMATION

## 磁性工具系列 Magnetic Tools

### 磁性焊接固定器

Magnetic welding holder

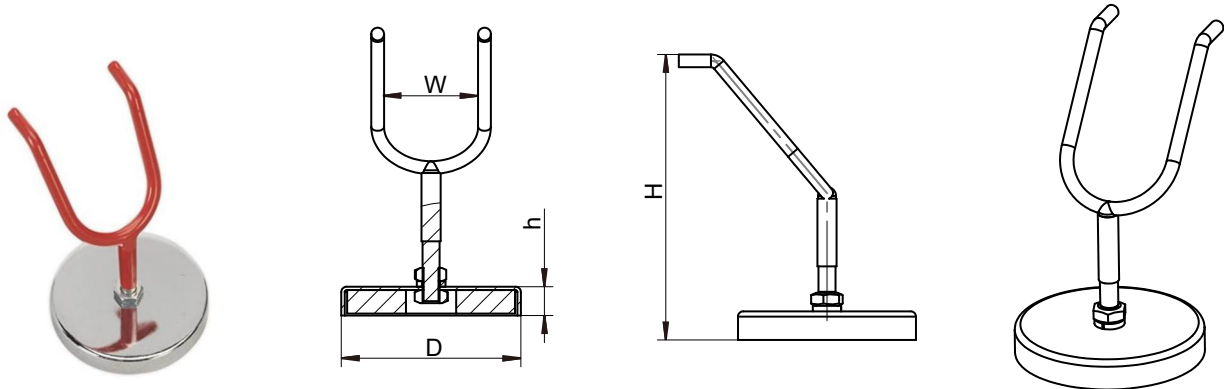

型号 Model	D (mm)	H (mm)	h (mm)	M	自重 Weight (g)	垂直拉脱力 V.P.O.Force (Lb)
TH2001	84	130	13.5	44	400	35

## 磁性工具系列 Magnetic Tools

### 磁性焊接固定器

Magnetic welding holder

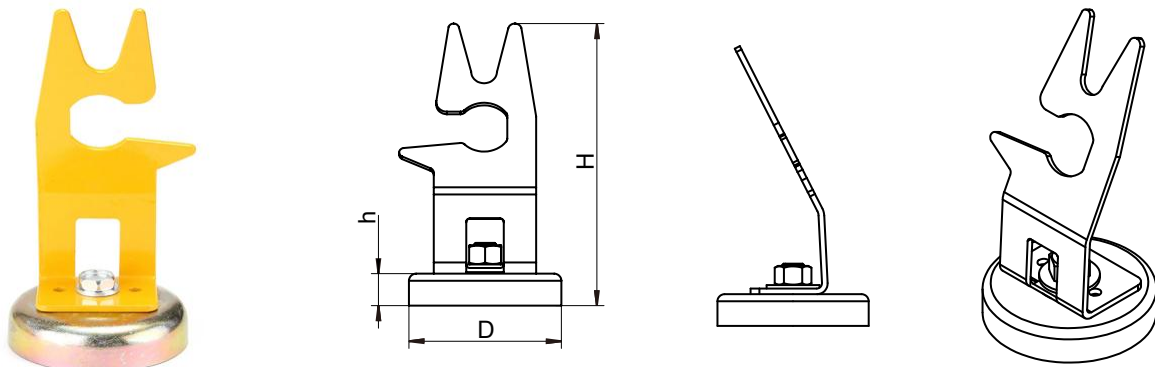

型号 Model	D (mm)	H (mm)	h (mm)	自重 Weight (g)	垂直拉脱力 V.P.O.Force (Lb)
TH2002	85	155	18	685	44

# PRODUCT INFORMATION

## 磁性工具系列 Magnetic Tools

### 磁性焊接固定器

Magnetic welding holder

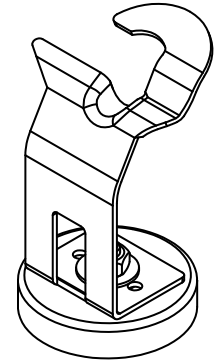
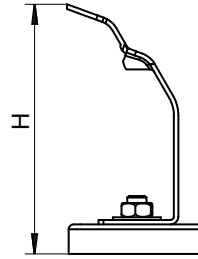
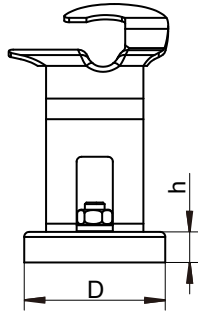

型号 Model	D (mm)	H (mm)	h (mm)	自重 Weight (g)	垂直拉脱力 V.P.O.Force (Lb)
TH2004	85	145	18	737	44

## 磁分离系列 Magnetic Separation

### 特氟龙磁棒

Teflon coated magnet

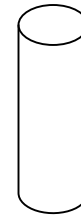
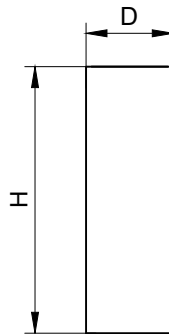

型号 Model	D (mm)	H (mm)	自重 Weight (g)	最高耐温 Max Temp (°C)	最高表磁 Magnetic Field (GS)
PTFE6580	17	52	60	< 80	6500
PTFE7580	17	52	60	< 80	7500
PTFE6515	17	52	60	< 150	6500
PTFE7515	17	52	60	< 150	7500
PTFE6525	17	52	60	< 250	6500

# PRODUCT INFORMATION

## 设备系列 Equipment

### 小型数显拉力机

Small digital tension machine



型号 Model	L (mm)	W (mm)	H (mm)	自重 Weight (kg)	量程 Range (kg)
ZP-1000	320	250	490	10	0-100

# PRODUCT INFORMATION

## 配件系列 Accessories

### 不锈钢吊环, 外螺纹

Stainless steel ring, with external thread

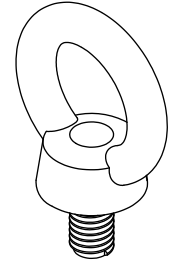
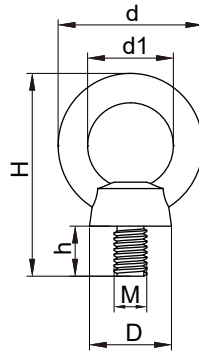

型号 Model	D (mm)	d (mm)	d1 (mm)	h (mm)	H (mm)	M	自重 Weight (g)
CM5	14.5	23.2	13.4	11.2	34.8	M5	15
CM6	15	26.5	16	11.5	41	M6	20.6
CM8	18	34.5	19.5	14.5	51	M8	40.6
CM10	22	41.5	25	18	60.5	M10	73.2
CM12	26.5	47	29	20	68	M12	112

## 配件系列 Accessories

### 不锈钢吊环, 内螺纹

Stainless steel ring, with screwed bush

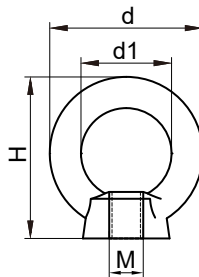

型号 Model	D (mm)	d (mm)	d1 (mm)	H (mm)	M	自重 Weight (g)
DM4	8.5	19	10	19	M4	5.2
DM5	11	22.5	12	23	M5	9.8
DM6	14.5	27	15.5	29	M6	18.5
DM8	18.5	34.5	19.5	34	M8	36
DM10	21.5	41	24.5	41	M10	57.8
DM12	27.5	50	27.5	47.5	M12	99.7

# PRODUCT INFORMATION

## 配件系列 Accessories

### 不锈钢螺丝

Stainless steel screw

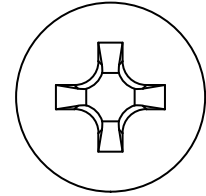
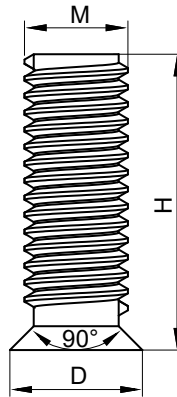

型号 Model	D (mm)	L (mm)	M	自重 Weight (g)
M5	9	12	M5	2
M6	11.5	17	M6	2.9
M8	15	20	M8	7.7
M8	15	25	M8	9
M10	17.5	30	M10	17.9
M12	21.5	35	M12	30.5

## 配件系列 Accessories

### 铁片

Metal plate

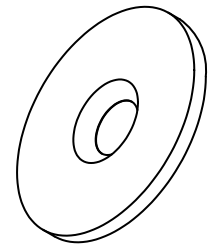
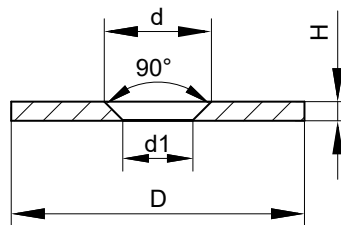

型号 Model	D (mm)	d (mm)	d1 (mm)	H (mm)	自重 Weight (g)
D12*1.5	12	8.4	5.4	1.5	0.9
D15*1.5	15	8.4	5.5	1.5	1.5
D18*1.5	18	8.4	5.5	1.5	2.7
D20*2	20	8.2	5	2	4.4
D23*1.5	23	8.4	5.5	1.5	4.4
D27*3	27	11.6	5.6	3	13.4
D32*3	32	11.6	5.6	3	17.6
D34*3	34	11.6	5.6	3	21.2
D42*3	42	11.6	5.6	3	32.4
D50*3	50	11.6	5.6	3	44.6
D62*3	62	11.6	5.8	3	61.9

# PRODUCT INFORMATION

## 配件系列 Accessories

### 橡胶套

Rubber Sleeve

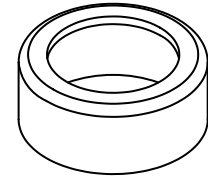
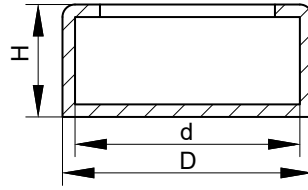

型号 Model	D (mm)	d (mm)	H (mm)	自重 Weight (g)
RS16	19.2	16.2	7.1	1
RS20	23.2	20.2	9.1	2
RS25	28.2	25.2	10.1	2.5
RS32	35.2	32.2	10.1	3.5
RS36	37.6	36	9.2	3.5
RS40	44.2	40.2	11.1	7
RS42	46.2	42.2	12.1	9.5
RS48	52.2	48.2	14.1	11.5
RS60	63	60	16	13.5
RS75	79.2	75.2	21.1	26

## 配件系列 Accessories

### 折叠登山爪/飞虎爪

Grappling Hook

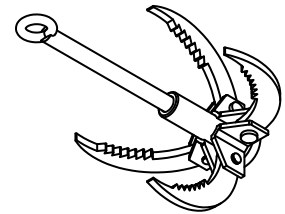
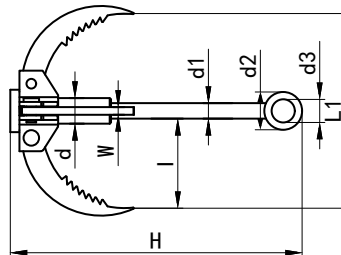

型号 Model	H (mm)	d (mm)	d1 (mm)	d2 (mm)	d3 (mm)	l (mm)	L (mm)	W (mm)	自重 Weight (g)
205*230	230	19.8	12	16.5	29.5	90	205	6	767

## 配件系列 Accessories

### 登山爪/飞虎爪

Grappling Hook

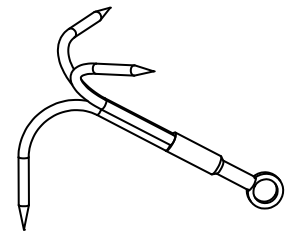
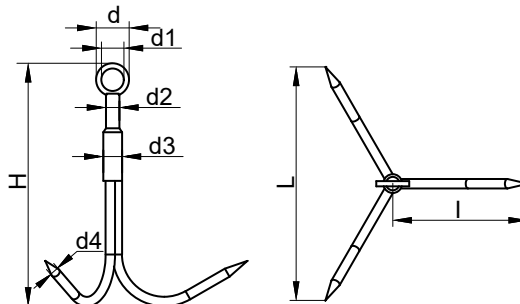

型号 Model	H (mm)	d (mm)	d1 (mm)	d2 (mm)	d3 (mm)	d4 (mm)	l (mm)	L (mm)	自重 Weight (g)
95*115	115	12	17.5	7.5	10	5	54	95	69
130*130	130	14.5	21.5	8.5	12	6	75	130	111
145*190	190	19.5	29.5	11.5	16	8	75	145	291
180*255	255	28	40	16	20	10	90	180	600

# PRODUCT INFORMATION

## 配件系列 Accessories

### 打捞绳

Fishing Magnet Rope



型号 Model	绳子直径 Rope Diameter (mm)	绳子长度 Rope Length (m)	承重 Load (kg)	自重 Weight (g)
D4*10	4	10	110	155
D4*20	4	20	110	260
D4*30	4	30	110	335
D6*10	6	10	180	260
D6*20	6	20	180	445
D6*30	6	30	180	560
D8*10	8	10	320	375
D8*20	8	20	320	790
D8*30	8	30	320	1080

## 配件系列 Accessories

### 工具箱

Fishing Magnet Toolbox

型号 Model	自重 Weight (g)
32*26.5*12.5cm	700



## 配件系列 Accessories

### 打捞手套

Fishing Magnet Glove

材料 Material
尼龙丁腈 Nylon nitrile



## 配件系列 Accessories

### 螺纹紧固胶

Threadlocker

剂量 Volume
10ml



## 表面处理

Surface Treatment

镀层类型 Plating Type	镀层厚度 Plating Thickness	颜色 Colour	使用温度 Working Temperature	耐盐雾 Salt Spray Test	特点 Characteristic
镍 Nickel	10-30μm	亮银色 Bright Silver	≤200°C	6H-24H	耐盐雾，耐湿热良好。 适用于清洁环境。 Good performance under saltspray test and constant temperature &
锌 Zinc	5-10μm	暗银色 Dark Silver	≤160°C	6H-48H	适用多数产品的防护。 Suitable for common environments.
电泳漆 Electrophoresis	10-30μm	白, 黄, 红, 绿, 蓝, 紫, 黑	≤120°C	48H-72H	耐盐雾，耐湿热良好。 配色丰富。 Good performance under saltspray test and constant temperature &



## 操作说明

### Handling Magnets



#### 磁制品使用注意：

磁制品的吸引力和排斥力存在着安全隐患，磁制品甚至可以在很远的距离吸引和排斥，所以操作时有受伤的风险，需注意。

烧结磁铁是硬但脆的，当它们碰撞时会分裂成锋利的碎片，在任何时候都应避免任何类型的碰撞。磁铁强大的吸引力容易弄伤皮肤，新手操作时建议配备合适的防护工具。

#### Processing of magnets:

The magnet's attracting and repelling forces represent a potential safety hazard. Magnets can attract and repel even at great distances - thus representing a risk of injury.

Sintered magnets are hard, brittle and, when they collide, break apart into sharp-edged pieces. Any type of collision should be avoided at all times.

The powerful attractive forces of the magnet can crush one's skin, so work only when wearing suitable protective clothing!



#### 磁制品的应用环境注意：

磁铁及制品的相互作用容易产生火花，尽量避免安装在有潜在爆炸性风险的环境中。

强大的磁场对电气及电子设备有较大的影响，特别是心脏起搏器，请注意。

#### Magnet applications:

Magnets may not be installed in potentially explosive environments because it could cause sparking.

Strong magnetic fields may affect electrical or electronic devices. This is also true of pacemakers.

We are not aware of any adverse affects to the human body as a result of exposure to magnetic fields.



#### 磁制品的运输：

磁铁及磁制品在道路和海运运输中可正常运输；但对于航空运输，外包装须参照IATA（国际航空运输协会）第953号危险货物的包装规定。

当进行包裹运输时，不恰当的包装容易引起问题，例如在运输过程中对其他包裹（电子设备，芯片卡等）产生影响，而且容易造成包裹表面吸附一些金属物品，请尽量避免。

#### Shipping of magnets:

Magnets are not classified as hazardous goods when shipped by road or sea. For air shipments, please refer to the packaging regulations for hazardous goods No. 953 of the IATA (International Air Transport Association).

When shipping via parcel services, magnets can lead to problems if not packaged properly. For example, this could affect goods (electronic devices, chip cards) in other parcels or the sorting equipment of the parcel service.

The parcel could also become attached to metallic objects during transport.

## About XHMAG

■■ XHMAG



XHMAG focuses on magnetic products, offering innovative magnetic solutions.  
We firmly believe that continuous innovation drives company development.  
We are glad to share technical expertise with you, to meet your specific magnet needs.  
Our vision is to create a wonderful future together with our customers.

### ■■■■ / Contact Us:

- Company: HEFEI XINHUI MAGNET CO., LTD
- ADD.: No.XXX, XXXXXX Road, XXXX District, Hefei, Anhui, China
- TEL: +86-551-63447437
- Website: www.xhmag.com
- Email: sales@xhmag.com